



Capacitance Probes

A capacitance probe is a point level indicator, commonly used for high or low level detection in a bin, tank or silo. BinMaster capacitance probes offer fail-safe operation, “quick-set” calibration, plus interference-free operation—working far below the RF level of 9 KHz at just 6 KHz—so they will not interfere with two-way radios or other equipment operating in the radio spectrum.

Description	Part No.
PRE-CONFIGURED PROBES	
CompactPro 115 VAC Compact capacitance probe with buildup protection	730-0250
CompactPro 230 VAC Compact capacitance probe with buildup protection	730-0257
CompactPro 24 VDC Compact capacitance probe with buildup protection	730-0256
1.00" NPS to 1.25" NPT fitting	175-0118
PROCAP I – 24 - Standard OEM capacitance probe with universal power supply 24 to 240 VAC/ VDC with LED status light, triple thread screw off cover, dual conduit entries, DPDT relay con- tacts, selectable fail-safe protection, FDA recognized powder coat finish, shielded bare stainless steel 24" probe, 3/4" SS and 1-1/4" aluminum fittings standard, hazardous location approved, C/ US listed for Class II, Groups E, F, G, with dual time delay	730-0516
PROCAP II – 24 - Standard OEM capacitance probe with selectable 115/230 VAC with LED status light, triple thread screw off cover, dual conduit entries, DPDT relay contacts, selectable failsafe protection, FDA recognized powder coat finish, shielded bare stainless steel 24" probe, 3/4" SS and 1-1/4" aluminum fittings standard, hazardous location approved, C/US listed for Class II, Groups E, F, G, with dual time delay	730-0517

Mark X if none			
Sample			
PC1.	FA	XXXX	11PO1

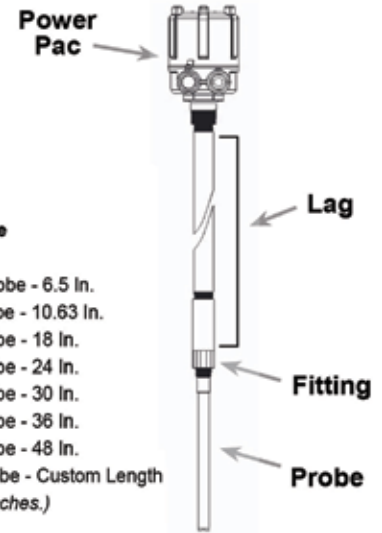

Probes - additional probes on next page

Delrin - Shielded (1, 2, 4)

- 06P58:** P58 - Shielded, Delrin Sleeved Probe - 6.5 In.
- 11P01:** P1 - Shielded, Delrin Sleeved Probe - 10.63 In.
- 18P02:** P2 - Shielded, Delrin Sleeved Probe - 18 In.
- 24P03:** P3 - Shielded, Delrin Sleeved Probe - 24 In.
- 30P04:** P4 - Shielded, Delrin Sleeved Probe - 30 In.
- 36P05:** P5 - Shielded, Delrin Sleeved Probe - 36 In.
- 48P06:** P6 - Shielded, Delrin Sleeved Probe - 48 In.
- XXP07:** P7 - Shielded, Delrin Sleeved Probe - Custom Length
(Replace XX with length in inches.)

Delrin - Shielded - 3A (3)

- 06P67:** P67 - Shielded, Delrin Sleeved 3-A/USDA Probe - 6.5 In.
- 11P43:** P43 - Shielded, Delrin Sleeved 3-A/USDA Probe - 11 In.
- 18P44:** P44 - Shielded, Delrin Sleeved 3-A/USDA Probe - 18 In.
- 24P45:** P45 - Shielded, Delrin Sleeved 3-A/USDA Probe - 24 In.
- 30P46:** P46 - Shielded, Delrin Sleeved 3-A/USDA Probe - 30 In.
- 36P47:** P47 - Shielded, Delrin Sleeved 3-A/USDA Probe - 36 In.
- 48P48:** P48 - Shielded, Delrin Sleeved 3-A/USDA Probe - 48 In.
- XXP49:** P49 - Shielded, Delrin Sleeved 3-A/USDA Probe - Custom Length
(Replace XX with length in inches.)

Lags - (Use XXXX if none)

- XXLG:** Lagged Probe Fitting - Galvanized (1, 2, 4)
(Replace XX with length in inches.)
- XXLS:** Lagged Probe Fitting - SS (1, 2, 4)
(Replace XX with length in inches.)

Fittings

- FA:** FA - Probe Fitting - 3/4 In. NPT SS for Bare and Delrin Probes (1, 2, 4)
- FB:** FB - Probe Fitting - 1.25 In. NPT SS for Bare and Delrin Probes (1, 2, 4)
- FC:** FC - Probe Fitting - 1 In. Food Grade SS for Bare and Delrin Probes (1, 2, 4)
- FD:** FD - Probe Fitting - 3/4 In. NPT SS for Teflon Probes (1, 2, 4)
- FE:** FE - Probe Fitting - 1 In. Food Grade SS for Teflon Probes (1, 2, 4)
- FF:** FF - Probe Fitting - 1.25 In. NPT SS for Teflon Probes (1, 2, 4)
- FG:** FG - Probe Fitting - 1 In. Sanitary SS for 3-A Tri-Clover Clamp (3)
- FH:** FH - Probe Fitting - 2.5 In. Sanitary SS for 3-A Tri-Clover Clamp (3)
- FI:** FI - Probe Fitting - 3/4 In. SS NPT Extended Lag for Bare and Delrin Probes (1, 2, 4)
- FJ:** FJ - Probe Fitting - 3/4 In. SS NPT Extended Lag for Teflon Probes (1, 2, 4)
- FK:** FK - Probe Fitting - 2 In. Sanitary SS for 3-A Tri-Clover Clamp (3)
- FM:** FM - Probe Fitting - 1.5 In. SS NPT for Bare and Delrin Probes (1, 2, 4)
- FN:** FN - Probe Fitting - 2 In. SS NPT for Bare and Delrin Probes (1, 2, 4)

Power Pacs

- PC1.:** PROCAP I
- PC2.:** PROCAP II
- PC1X.:** PROCAP IIX
- PC2X.:** PROCAP IIX
- PA1.:** PRO AUTO-CAL - 115 VAC
- PA2.:** PRO AUTO-CAL - 230 VAC
- PR1.:** PRO Remote 25 Ft. - 115 VAC
- PR2.:** PRO Remote 25 Ft. - 230 VAC
- PR3.:** PRO Remote 25 Ft. - LV 12-24 VAC/VDC
- PR4.:** PRO Remote 75 Ft. - 115 VAC
- PC13A.:** PROCAP I-3A
- PC23A.:** PROCAP II-3A

- 1: PCI & PCII & AutoCal
- 2: PCIX & PCIIIX
- 3: Pro Remote
- 4: PC13A & PCII3A

Mark X if none

Probes - additional probes on previous page

Delrin - Extended Shielded (1, 2, 4)

- 16P12: P12 - Extended Shield, Delrin Sleeved Probe - 15 In.
- 18P13: P13 - Extended Shield, Delrin Sleeved Probe - 18 In.
- 24P14: P14 - Extended Shield, Delrin Sleeved Probe - 24 In.
- 30P16: P15 - Extended Shield, Delrin Sleeved Probe - 30 In.
- 36P16: P16 - Extended Shield, Delrin Sleeved Probe - 36 In.
- 48P17: P17 - Extended Shield, Delrin Sleeved Probe - 48 In.
- XXP18: P18 - Extended Shield, Delrin Sleeved Probe - Custom Length
(Replace XX with length in inches.)

Delrin - Extended Shielded - 3A (3)

- 16P50: P50 - Extended Shield, Delrin Sleeved 3-A/USDA Probe - 15 In.
- 18P51: P51 - Extended Shield, Delrin Sleeved 3-A/USDA Probe - 18 In.
- 24P52: P52 - Extended Shield, Delrin Sleeved 3-A/USDA Probe - 24 In.
- 30P53: P53 - Extended Shield, Delrin Sleeved 3-A/USDA Probe - 30 In.
- 36P54: P54 - Extended Shield, Delrin Sleeved 3-A/USDA Probe - 36 In.
- 48P55: P55 - Extended Shield, Delrin Sleeved 3-A/USDA Probe - 48 In.

Delrin - Unshielded (1, 2, 4)

- 04P20: P20 - Unshielded, Delrin Sleeved Probe - 4 In.
- 06P72: P72 - Unshielded, Delrin Sleeved Probe - 6 In.
- 11P19: P19 - Unshielded, Delrin Sleeved Probe - 10.63 In.
- 18P21: P21 - Unshielded, Delrin Sleeved Probe - 18 In.
- 24P22: P22 - Unshielded, Delrin Sleeved Probe - 24 In.
- 30P23: P23 - Unshielded, Delrin Sleeved Probe - 30 In.
- 36P24: P24 - Unshielded, Delrin Sleeved Probe - 36 In.
- 48P25: P25 - Unshielded, Delrin Sleeved Probe - 48 In.
- XXP26: P26 - Unshielded, Delrin Sleeved Probe - Custom Length
(Replace XX with length in inches.)

Delrin - Unshielded - 3A (3)

- 04P68: P68 - Unshielded, Delrin Sleeved 3-A/USDA Probe - 4 In.
- 11P41: P41 - Unshielded, Delrin Sleeved 3-A/USDA Probe - 11 In.
- XXP42: P42 - Unshielded, Delrin Sleeved 3-A/USDA Probe - Custom Length
(Replace XX with length in inches.)

Teflon - Shielded (1, 2, 4)

- 07P70: P70 - Shielded, Teflon Sleeved Probe - 6.5 In.
- 11P08: P8 - Shielded, Teflon Sleeved Probe - 10.63 in.
- XXP09: P9 - Shielded, Teflon Sleeved Probe - Custom Length
(Replace XX with length in inches.)

Teflon - Extended Shielded (1, 2, 4)

- XXP04: P63 - Extended Shield, Teflon Sleeved Probe - Custom Length
(Replace XX with length in inches.)

Teflon - Unshielded (1, 2, 4)

- 11P37: P37 - Unshielded, Teflon Sleeved Probe - 10.63 In.
- XXP38: P38 - Unshielded, Teflon Sleeved Probe - Custom Length
(Replace XX with length in inches.)

Bare - Shielded (1, 2, 4)

- 07P83: P63 - Shielded, Bare Stainless Steel Probe - 7 In.
- 11P84: P84 - Shielded, Bare Stainless Steel Probe - 11 In.
- 18P85: P85 - Shielded, Bare Stainless Steel Probe - 18 In.
- 24P64: P64 - Shielded, Bare Stainless Steel Probe - 24 In.
- XXP74: P74 - Shielded, Bare Stainless Steel Probe - Custom Length
(Replace XX with length in inches.)

Bare - Unshielded (1, 2, 4)

- 03P71: P71 - Unshielded, Bare Stainless Steel Probe - 3 In.
- 04P28: P28 - Unshielded, Bare Stainless Steel Probe - 4 In.
- 08P62: P62 - Unshielded, Bare Stainless Steel Probe - 6 In.
- 11P27: P27 - Unshielded, Bare Stainless Steel Probe - 10.63 In.
- 18P29: P29 - Unshielded, Bare Stainless Steel Probe - 18 In.
- 24P30: P30 - Unshielded, Bare Stainless Steel Probe - 24 In.
- 30P67: P57 - Unshielded, Bare Stainless Steel Probe - 30 In.
- 36P66: P56 - Unshielded, Bare Stainless Steel Probe - 36 In.
- 48P31: P31 - Unshielded, Bare Stainless Steel Probe - 48 In.
- 72P32: P32 - Unshielded, Bare Stainless Steel Probe - 72 In.
- 96P33: P33 - Unshielded, Bare Stainless Steel Probe - 96 In.
- XXP34: P34 - Unshielded, Bare Stainless Steel Probe - Custom Length
(Replace XX with length in inches.)

Heavy Duty (1, 4)

- 07PHD: HD Heavy Duty Capacitance Probe - 6.5 in.
- 11PHD: HD Heavy Duty Capacitance Probe - 10.5 in.

Hanging

- XXP65: P65 - Hanging Flexible Cable Probe - Bare SS Shielded (1, 4)
(Replace XX with length in inches.)
- XXP76: P76 - Hanging Flexible Cable Probe - Bare SS Unshielded (1, 4)
(Replace XX with length in inches.)
- XXP86: P86 - Hanging Flexible Cable Probe - Probe Assembly (1, 4)
(Replace XX with length in inches.)
- XXP10: P10 - Hanging Flexible Cable Probe - Teflon Sleeved Shielded (1, 2, 4)
(Replace XX with length in inches.)
- XXP11: P11 - Hanging Flexible Cable Probe - Teflon Sleeved Shielded - Potted (1, 2, 4)
(Replace XX with length in inches.)

Bendable (1, 2, 4)

- 07P93: P93 - 7" Unshielded, Bare Bendable
- 07P92: P92 - 7" Unshielded, Teflon Coated Bendable
- 14P94: P94 - 13.75" Unshielded, bare bendable
- 14P89: P89 - 13.75" Unshielded, Teflon Coated Bendable
- XXP90: P90 - Unshielded, Bendable Teflon Coated Probe - Custom Length
(Replace XX with length in inches.)
- XXP91: P91 - Unshielded, Bendable Bare Probe - Custom Length
(Replace XX with length in inches.)

Flush (1, 2, 4)

- 00P69: P69 - Flush Mounted Probe with Buildup Shield
- 00P81: P81 - High Temp Flush Mount Assembly

Miscellaneous (1, 2, 4)

- 10P39: P39 - Bare SS Probe - 10.19 In.
- 14P88: P88 - Unshielded, Bare SS Probe with 90 Degree Bend
- XXP40: P40 - Bare SS Probe - Custom Length
(Replace XX with length in inches.)

1: PCI & PCII & AutoCal
2: PCIX & PCIIx
3: Pro Remote
4: PCI3A & PCII3A

Description	CODE	Part No.
POWER PACS		
PROCAP I power pac with universal power supply 24 to 240 VAC/VDC with LED status light, triple thread screw-off cover, dual conduit entries, DPDT relay contacts, selectable fail-safe protection, and FDA recognized powder coat finish, hazardous location approved, C/US listed for Class II, Groups E, F, G	PC1.	
PROCAP II power pac with selectable 115/230 VAC with LED status light, triple thread screw-off cover, dual conduit entries, DPDT relay contacts, selectable fail-safe protection, and FDA recognized powder coat finish, hazardous location approved, C/ US listed for Class II, Groups E, F, G	PC2.	
PROCAP IX power pac with universal power supply 24 to 240 VAC/VDC with triple thread screw-off cover, dual conduit entries, DPDT relay contacts, selectable fail-safe protection, FDA recognized powder coat finish, hazardous location approved, C/US listed for Class I, Groups C & D and Class II, Groups E, F, G	PC1X.	
PROCAP IIX power pac with selectable 115/230 VAC with triple thread screw-off cover, dual conduit entries, DPDT relay contacts, selectable fail-safe protection, FDA recognized powder coat finish, hazardous location approved, C/US listed for Class I, Groups C & D and Class II, Groups E, F, G	PC2X.	
PRO AUTOCAL 115 power pac with 115 VAC, PRO-Shield protection with continuous LED status light, auto calibration and function test, hazardous location approved, C/US listed for Class II, Groups E, F, G	PA1.	
PRO AUTOCAL 230 power pac with 230 VAC, PRO-Shield protection with continuous LED status light, auto calibration and function test, hazardous location approved, C/US listed for Class II, Groups E, F, G	PA2.	
PRO Remote 25' 115 power pac with remote electronics up to 25' from sensor, 115 VAC, intrinsically safe, hazardous location approved, C/US listed for Class I, Groups C & D, Class II, Groups E, F, G (Must order triax cable separately)	PR1.	
PRO Remote 25' 230 power pac with remote electronics up to 25' from sensor, 230 VAC, intrinsically safe, hazardous location approved, C/US listed for Class I, Groups C & D, Class II, Groups E, F, G (Must order triax cable separately)	PR2.	
PRO Remote 25' LV 12-24 power pac with remote electronics up to 25' from sensor, 12-24 VAC/DC (Must order triax cable separately)	PR3.	
PRO Remote 75' power pac with PRO-Shield protection, remote electronics up to 75' from sensor, 115/230 VAC, intrinsically safe, hazardous location approved, C/US listed for Class I, Groups C & D, Class II, Groups E, F, G (Must order triax cable separately)	PR4.	
PROCAP I-3A power pac with universal power supply 24 to 240 VAC/VDC with LED status light, triple thread screw-off cover, dual conduit entries, DPDT relay contacts, selectable fail-safe protection, 3-A and USDA recognized, hazardous location approved, C/ US listed for Class II, Groups E, F, G	PC13A.	
PROCAP II-3A power pac with selectable 115/230 VAC with LED status light, triple thread screw-off cover, dual conduit entries, DPDT relay contacts, selectable fail-safe protection, 3-A and USDA recognized, hazardous location approved, C/US listed for Class II, Groups E, F, & G	PC23A.	
FITTINGS		
FA - Probe fitting - 3/4 In. NPT SS for bare and Delrin probes	FA	175-0083
FB - Probe fitting - 1.25 In. NPT SS for bare and Delrin probes	FB	175-0082
FC - Probe fitting - 1 In. Food grade SS for bare and Delrin probes	FC	175-0093
FD - Probe fitting - 3/4 In. NPT SS for Teflon probes	FD	175-0097
FE - Probe fitting - 1 In. Food grade SS for Teflon probes	FE	175-0098
FF - Probe fitting - 1.25 In. NPT SS for Teflon probes	FF	175-0099
FG - Probe fitting - 1 In. Sanitary SS for 3-A tri-clover clamp	FG	175-0107
FH - Probe fitting - 2.5 In. Sanitary SS for 3-A tri-clover clamp	FH	175-0109
FI - Probe fitting - 3/4 In. SS NPT Extended lag for bare and Delrin probes	FI	416-0431
FJ - Probe fitting - 3/4 In. SS NPT Extended lag for Teflon probes	FJ	416-0432
FK - Probe fitting - 2 In. Sanitary SS for 3-A tri-clover clamp	FK	175-0223
FM - Probe fitting - 1.5 In. SS NPT for bare and Delrin probes	FM	175-0227
FN - Probe fitting - 2 In. SS NPT for bare and Delrin probes	FN	175-0237

Description	CODE	Part No.
LAG EXTENSION		
Lagged probe fitting - galvanized connector / stainless steel coupling. Mounting for lagged probe is via the 1.25" threading on the Power Pac only.	LG	416-0208
Lagged probe fitting - stainless steel connector / stainless steel coupling. Mounting for lagged probe is via the 1.25" threading on the Power Pac only.	LS	416-0207
PROBES: DELRIN - SHIELDED		
P58 - Shielded, Delrin sleeved probe - 6.5"	06P58	530-0277
P1 - Shielded, Delrin sleeve probe - 10.63"	11P01	530-0197
P2 - Shielded, Delrin sleeve probe - 18"	18P02	530-0243
P3 - Shielded, Delrin sleeve probe - 24"	24P03	530-0244
P4 - Shielded, Delrin sleeve probe - 30"	30P04	530-0245
P5 - Shielded, Delrin sleeve probe - 36"	36P05	530-0246
P6 - Shielded, Delrin sleeve probe - 48"	48P06	530-0247
P7 - Custom length, shielded, Delrin sleeved probe. Maximum length 60"	XXP07	530-0210
PROBES: DELRIN - SHIELDED - 3A		
P67 - Shielded, Delrin sleeved 3-A/USDA probe - 6.5"	07P67	530-0287
P43 - Shielded, Delrin sleeved 3-A/USDA probe - 11"	11P43	530-0225
P44 - Shielded, Delrin sleeved 3-A/USDA probe - 18"	18P44	530-0248
P45 - Shielded, Delrin sleeved 3-A/USDA probe - 24"	24P45	530-0249
P46 - Shielded, Delrin sleeved 3-A/USDA probe - 30"	30P46	530-0250
P47 - Shielded, Delrin sleeved 3-A/USDA probe - 36"	36P47	530-0251
P48 - Shielded, Delrin sleeved 3-A/USDA probe - 48"	48P48	530-0252
P49 - Custom length, shielded, Delrin sleeved, 3-A probe. Maximum length 60"	XXP49	530-0233
PROBES: DELRIN - EXTENDED SHIELDED		
P12 - Extended shield, Delrin sleeved probe - 15"	15P12	530-0259
P13 - Extended shield, Delrin sleeved probe - 18"	18P13	530-0254
P14 - Extended shield, Delrin sleeved probe - 24"	24P14	530-0255
P15 - Extended shield, Delrin sleeved probe - 30"	30P15	530-0256
P16 - Extended shield, Delrin sleeved probe - 36"	36P16	530-0257
P17 - Extended shield, Delrin sleeved probe - 48"	48P17	530-0258
P18 - Custom length, extended shield, Delrin sleeved probe. Maximum length 48"	XXP18	530-0264
PROBES: DELRIN - EXTENDED SHIELDED - 3A		
P50 - Extended shield, Delrin sleeved 3-A/USDA probe - 15"	15P50	530-0269
P51 - Extended shield, Delrin sleeved 3-A/USDA probe - 18"	18P51	530-0270
P52 - Extended shield, Delrin sleeved 3-A/USDA probe - 24"	24P52	530-0271
P53 - Extended shield, Delrin sleeved 3-A/USDA probe - 30"	30P53	530-0272
P54 - Extended shield, Delrin sleeved 3-A/USDA probe - 36"	36P54	530-0273
P55 - Extended shield, Delrin sleeved 3-A/USDA probe - 48"	48P55	530-0274
PROBES: DELRIN - UNSHIELDED		
P20 - Unshielded, Delrin sleeved probe - 4"	04P20	530-0260
P72 - Unshielded, Delrin sleeved probe - 6"	06P72	530-0221

Description	CODE	Part No.
P19 - Unshielded, Delrin sleeved probe - 10.63"	11P19	530-0196
P21 - Unshielded, Delrin sleeved probe - 18"	18P21	530-0238
P22 - Unshielded, Delrin sleeved probe - 24"	24P22	530-0239
P23 - Unshielded, Delrin sleeved probe - 30"	30P23	530-0240
P24 - Unshielded, Delrin sleeved probe - 36"	36P24	530-0241
P25 - Unshielded, Delrin sleeved probe - 48"	48P25	530-0242
P25 - Custom length, unshielded, Delrin sleeved probe. Maximum length 60"	XXP26	530-0213
PROBES: DELRIN - UNSHIELDED - 3A		
P68 - Unshielded, Delrin sleeved 3-A/USDA probe - 4"	04P68	530-0288
P41 - Unshielded, Delrin sleeved 3-A/USDA probe - 11"	11P41	530-0296
P42 - Custom length, unshielded Delrin sleeved 3-A probe. Maximum length 60"	XXP42	530-0229
PROBES: TEFLON - SHIELDED		
P70 - Shielded, Teflon sleeved probe - 6.5"	07P70	530-0295
P8 - Shielded, Teflon sleeved probe - 10.63"	11P08	530-0214
P9 - Custom length shielded, Teflon sleeved probe. Maximum length 60"	XXP09	530-0211
PROBES: TEFLON - EXTENDED SHIELDED		
P63 - Custom length, extended shield, Teflon sleeved probe. Maximum length 48"	XXP63	530-0276
PROBES: TEFLON - UNSHIELDED		
P37 - Unshielded, Teflon sleeved probe - 10.63"	11P37	530-0215
P38 - Custom length, unshielded, Teflon sleeved probe. Maximum length 96"	XXP38	530-0212
PROBES: BARE - SHIELDED		
P83 - Shielded, bare stainless steel probe - 7"	07P83	530-0529
P84 - Shielded, bare stainless steel probe - 11"	11P84	530-0530
P85 - Shielded, bare stainless steel probe - 18"	18P85	530-0531
P64 - Shielded, bare stainless steel probe - 24"	24P64	530-0501
P74 - Custom length, shielded, bare stainless steel probe. Maximum length 78"	XXP74	530-0526
PROBES: BARE - UNSHIELDED		
P71 - Unshielded, bare stainless steel probe - 3"	03P71	530-0199
P28 - Unshielded, bare stainless steel probe - 4"	04P28	530-0267
P62 - Unshielded, bare stainless steel probe - 6"	06P62	530-0202
P27 - Unshielded, bare stainless steel probe - 10.63"	11P27	530-0198
P29 - Unshielded, bare stainless steel probe - 18"	18P29	530-0268
P30 - Unshielded, bare stainless steel probe - 24"	24P30	530-0234
P57 - Unshielded, bare stainless steel probe - 30"	30P57	530-0265
P56 - Unshielded, bare stainless steel probe - 36"	36P56	530-0266
P31 - Unshielded, bare stainless steel probe - 48"	48P31	530-0235
P32 - Unshielded, bare stainless steel probe - 72"	72P32	530-0236
P33 - Unshielded, bare stainless steel probe - 96"	96P33	530-0237
P34 - Custom length, unshielded, bare stainless steel probe. Maximum length 96"	XXP34	530-0200

Description	CODE	Part No.
PROBES: HEAVY DUTY		
HD Heavy Duty Capacitance Probe - This rugged probe comes in a standard 6.5" length and features a PRO-Shield to guard against false readings from material buildup on the probe, with 1-1/4" SS process connection.	07PHD	530-0855
HD Heavy Duty Capacitance Probe - This rugged probe comes in a standard 10.5" length and features a PRO-Shield to guard against false readings from material buildup on the probe, with 1-1/4" SS process connection.	11PHD	530-0834
PROBES: HANGING		
P65 - Bare stainless steel, shielded, hanging flexible cable extension. Sold per foot.	XXP65	530-0535
P76 - Bare stainless steel, unshielded, hanging flexible cable extension with Teflon insert for high temperatures. Sold per foot.	XXP76	530-0325
P86 - Probe assembly, bare stainless steel, sleeved extended shield, hanging flexible cable probe. Sold per foot.	XXP86	530-0524
P10 - Teflon sleeved, shielded, hanging flexible stainless steel cable extension. Sold per foot.	XXP10	530-0231
P11 - Teflon sleeved, shielded, hanging flexible stainless steel cable extension, potted. Sold per foot.	XXP11	530-0232
PROBES: BENDABLE		
P93 - 7" Unshielded, bare bendable probe, includes 3/4" NPT fitting	07P93	530-0863
P92 - 7" Unshielded, Teflon-coated bendable probe, includes 3/4" NPT fitting	07P92	530-0600
P94 - 13.5" Unshielded, bare bendable probe, includes 3/4" NPT fitting	14P94	530-0862
P89 - 13.75" Unshielded, Teflon-coated bendable probe, includes 3/4" NPT fitting	14P89	530-0544
P90 - Custom length, unshielded, Teflon-coated bendable probe, includes 3/4" NPT fitting. Maximum length 48".	XXP90	530-0571
P91 - Custom length, unshielded, bare bendable probe, includes 3/4" NPT fitting. Maximum length 48".	XXP91	530-0564
PROBES: FLUSH		
P69 - Flush mounted probe with buildup shield	00P69	530-0082
P81 - High temperature flush mount assembly for temperatures up to 450°F	00P81	530-0194
PROBES: MISCELLANEOUS		
P39 - 10.19" Bare stainless steel probe. Teflon insert for high temperature	10P39	530-0227
P88 - 13.75" Unshielded, bare 5/8" diameter stainless steel probe with 90° bend	14P88	530-0546
P40 - Custom length, bare stainless steel probe with Teflon insert for high temperatures. Maximum length 96"	XXP40	530-0228
MOUNTING PLATES: STANDARD MOUNTS		
GRMP-1 - 0° Mild carbon steel half coupling 1.25" with black neoprene gasket		730-0020
GRMP-3 - 0° Stainless steel half coupling 1.25" mounting plate with black neoprene gasket		730-0021
GRMP-9 - 10° Mild carbon steel full coupling 1.25", powder coated with black neoprene gasket		730-0489
GRMP-13 - 30° Mild carbon steel full coupling 1.25", powder coated with black neoprene gasket		730-0508
GRMP-14 - 0° Mild carbon steel half coupling 1.25" with white silicone gasket		730-0567
GRMP-16 - 20° Mild carbon steel full coupling 1.25", powder coated with black neoprene gasket		730-0663
MOUNTING PLATES: BLIND FLANGE MOUNTS		
1" Carbon steel 150 # raised face mounting flange, 3/4" NPT		299-0530
2" Carbon steel 150 # raised face mounting flange, 3/4" NPT		299-0531
3" Carbon steel 150 # raised face mounting flange, 3/4" NPT		299-0532
4" Carbon steel 150 # raised face mounting flange, 3/4" NPT		299-0533
1" Stainless steel 150 # raised face mounting flange, 3/4" NPT		299-0534
2" Stainless steel 150 # raised face mounting flange, 3/4" NPT		299-0535
3" Stainless steel 150 # raised face mounting flange, 3/4" NPT		299-0536
4" Stainless steel 150 # raised face mounting flange, 3/4" NPT		299-0537

Description	CODE	Part No.
4" Stainless steel 150 # raised face mounting flange, 1-1/4" NPT		299-0853
MOUNTING PLATES: FLUSH MOUNTING OPTIONS		
Steel bin wall adapter for thick bin walls and hopper bottoms		290-0071
Bin wall adapter, 5/8" polyethylene		290-0069
ACCESSORIES		
Tri-clover clamp for 1 in. sanitary fitting tri-clover style, quick disconnect clamp for 1" sanitary fitting		215-0146
Tri-clover 1" Stainless steel welding ferrule flange		175-0110
Gasket for Tri-clover clamp connection		280-0054
REMOTE CABLE/BOX		
ft. Triax cable, Teflon 75 Ohm, used with PRO Remote up to 500°F (260°C)		398-0077
ft. Triax cable, Polyethylene 75 Ohm, used with PRO Remote up to 250°F (120°C)		398-0093
Triax cable kit with prepared end (for use with PRO Remote 25), Teflon 75 Ohm, used with the PRO Remote 25 up to 500°F (260°C)		530-0310
Triax cable kit with prepared end (for use with PRO Remote 25), Teflon 75 Ohm, used with the PRO Remote 25 up to 250°F (120°C)		530-0300
Pro Remote 25 standard electronic module 115 VAC		730-0532
Pro Remote 25 two conduit electronic module 115 VAC		730-0771
Pro Remote 25 standard electronic module 230 VAC		730-0533
Pro Remote 25 two conduit electronic module 230 VAC		730-0772
Pro Remote 75 standard electronic module 115/230 VAC		730-0535



PROCAP I

- Bright LED status indicator
- Universal power supply
- Triple thread screw-off cover
- Dual conduit entries
- DPDT relay contacts
- Adjustable sensitivity to 0.5 pF
- Easy "Quick-Set" calibration
- Hazardous location approvals



PROCAP II

- Bright LED status indicator
- 115/230 VAC Power supply
- Triple thread screw-off cover
- Dual conduit entries
- DPDT relay contacts
- Adjustable sensitivity to 0.5 pF
- Easy "Quick-Set" calibration
- Hazardous location approvals



PROCAP IX

- Exp. proof Class I, Groups C & D, Class II, Groups E, F & G
- Intrinsically safe
- Universal power supply
- Triple thread screw-off cover
- Dual conduit entries
- DPDT fail-safe relay contacts
- Easy "Quick-Set" calibration



PROCAP IIX

- Exp. proof Class I, Groups C & D, Class II, Groups E, F & G
- Intrinsically safe
- Universal power supply
- Triple thread screw-off cover
- Dual conduit entries
- DPDT fail-safe relay contacts
- Easy "Quick-Set" calibration



PROCAP I 3-A

- Meets 3-A & USDA standards
- Universal power supply
- Bright LED status indicator
- Triple thread screw-off cover
- Dual conduit entries
- DPDT fail-safe relay contacts
- Easy "Quick-Set" calibration
- Hazardous location approval



PROCAP II 3-A

- Meets 3-A & USDA standards
- 115/230 VAC Power supply
- Bright LED status indicator
- Triple thread screw-off cover
- Dual conduit entries
- DPDT fail-safe relay contacts
- Easy "Quick-Set" calibration
- Hazardous location approval



PRO Remote

- Remote electronics located in separate housing, designed for high temp. and vibration
- Explosion proof & intrinsically safe
- DPDT fail-safe relay contacts
- Easy "Quick-Set" calibration
- Adjustable sensitivity to 0.5 pF



PRO Auto-Cal

- Automatic calibration & testing without removing cover
- Bright LED status indicator
- 115/230 VAC power supply
- DPDT fail-safe relay contacts
- Easy "Quick-Set" calibration
- Adjustable sensitivity to 0.5 pF
- Hazardous location approvals

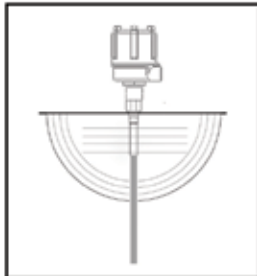

**Shielded Bare SS
OEM Probe**

The bare stainless steel probe is our most versatile all-purpose probe whose length can be modified in the field. It works reliably in bulk solids, slurries, and liquids. It has a rugged 5/8" diameter stainless steel probe featuring "PRO-Shield" protecting against false readings because of buildup or coating.

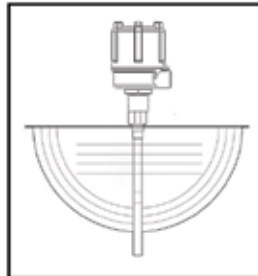

**Shielded Delrin or
Teflon Shielded
Probe**

The Delrin/Teflon sleeved probe is a versatile all-purpose fully insulated probe. It works reliably in bulk solids, slurries, and liquids. It has a rugged 5/8" diameter stainless steel probe featuring "PRO-Shield" protecting against false readings because of buildup or coating. Available in lengths from 6.5" to 96".

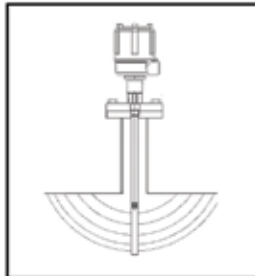

**Extended Shield
Delrin or Teflon
Sleeved Probe**

Designed with a 10" extended PRO-Shield, used when mounting the probe through a nozzle of standpipe. It works reliably in bulk solids, slurries, and liquids. It has a rugged 5/8" diameter stainless steel probe featuring "PRO-Shield" protecting against false readings because of buildup or coating. Available in lengths from 15" to 48".

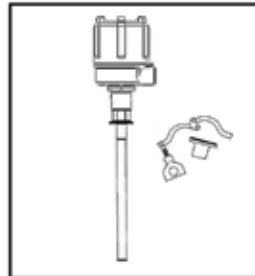

**Shielded Delrin
Sleeved Sanitary
3-A Probe**

Sanitary probe meets 3-A and USDA standards, conforming to the food industry's most demanding requirements for material, surfaces, and clean-in-place construction. This probe is designed for quick disconnect from tank to facilitate ease of inspection and cleaning.

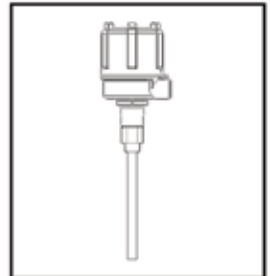

**Unshielded Delrin
or Teflon Sleeved
Probe**

The unshielded full insulated Delrin/Teflon sleeved probe is designed to be a lower cost, yet versatile probe. This probe works reliably in bulk solids, powders, slurries, and liquids. Used in applications that require top-mounting or can be side-mounted in free flowing materials.



**Shielded Bare
SS Probe**

This is an unshielded probe whose length can be modified in the field. It can be cut back to 3" or extended to 8'. The probe will work reliably in a variety of powders and dry solid materials. Used in applications that require top-mounting or can be side-mounted in free flowing materials.

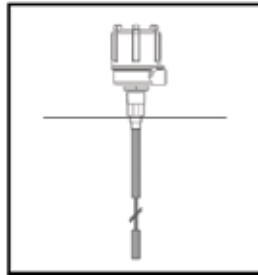

**Unshielded Custom
Length Bare SS
Hanging Flexible Cable**

The flexible cable extension was designed for high, mid or low level detection when it is necessary to top mount. This probe is also very effective in aggregate, coal, or other lump materials that might damage a rigid probe. Maximum length of the cable is 35'. Cable can be cut to length in the field.

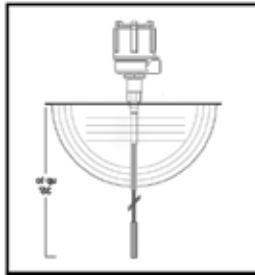

**Shielded Custom Length
Bare SS Hanging
Flexible Cable Probe**

This probe was designed for high, mid, or low level applications when it is necessary to top mount. This probe features Pro-Shield protection against false readings due to buildup and will also allow you to mount the probe in a stand-off pipe or nozzle. Maximum cable length is 35'.

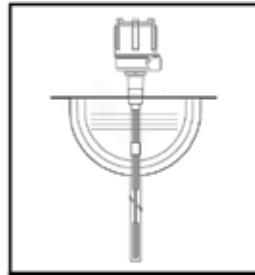

**Shielded Custom Length
Teflon Sleeved Hanging
Flexible Cable Extension**

The Teflon sleeved flexible cable was designed for high, mid or low level applications when it is necessary to top mount. The Teflon coated extension is also used in material not compatible with stainless steel, or in situations where high humidity or other internal tank conditions may short-out a bare probe.

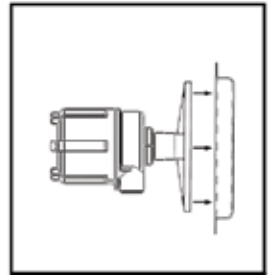

**Shielded Flush
Mounted Probe with
Bin Wall Adapter**

No probe intrusion designed for space constrained areas or applications where material flow or bridging may damage standard probes. The probe mounts flush on a vessel wall, conveyer housing or chute. An optional bin wall adapter is available when working with thick walls or angled hoppers.

Description	Part No.
PROCAP CAPACITANCE PROBE PARTS	
Capacitance probe housing gasket	280-0072
Capcitance probe red lens cover	335-0071
PROCAP I, II, IX, & IIX main PCB	530-0614
PROCAP I & IX PCB power supply 24 to 240 VAC/VDC	530-0476
PROCAP II & IIX PCB power supply 115/230 VAC	530-0477
PROCAP I & IX Complete kit, includes PCB power supply 24 to 240 VAC/VDC, PROCAP Main PCB, mounting bracket and screws (fully assembled)	530-0554
PROCAP II & IIX Complete kit, includes PCB power supply 115/230 VAC, PROCAP Main PCB, mounting bracket and screws (fully assembled)	530-0555
PROCAP I & IX fuse	328-0064
PROCAP II & IIX fuse	328-0039
PCB for Pro Remote 25 - no enclosure	530-0146
PCB for Pro Remote 75 - no enclosure	530-0084
PCB for Pro Remote to replace board in sensor	530-0633