

# INSTRUCTION MANUAL

## MA871

### Digital Sucrose Refractometer





**THANK YOU for choosing Milwaukee Instruments!**

**This instruction manual will provide you the necessary information for correct use of the meters.**

*All rights are reserved. Reproduction in whole or in part is prohibited without the written consent of the copyright owner, Milwaukee Instruments Inc., Rocky Mount, NC 27804 USA.*

## TABLE OF CONTENTS

1. FUNCTIONAL DESCRIPTION .....	4
2. GENERAL DESCRIPTION.....	6
3. SPECIFICATIONS .....	7
4. PRINCIPLE OF OPERATION.....	8
5. MEASUREMENT GUIDELINES.....	9
6. CALIBRATION PROCEDURE.....	10
7. MEASUREMENT PROCEDURE.....	12
8. MAKING A STANDARD % BRIX SOLUTION .....	13
9. CHANGING TEMPERATURE UNIT .....	14
10. ERROR MESSAGES .....	15
11. BATTERY REPLACEMENT .....	17
CERTIFICATION .....	18
RECOMMENDATION .....	18
WARRANTY.....	18

## 1. FUNCTIONAL DESCRIPTION

### Display

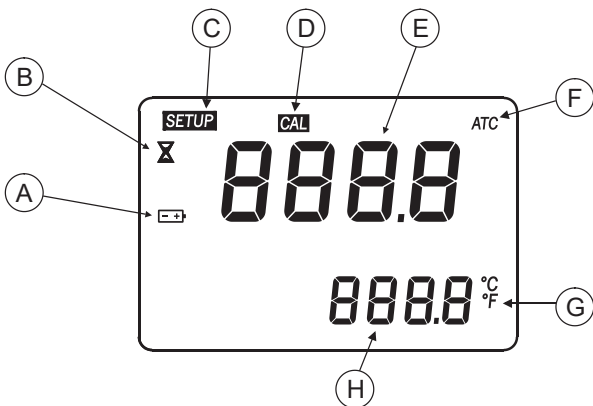

- A. BATTERY STATUS ICON  
(BLINKS WHEN LOW BATTERY CONDITION DETECTED)
- B. MEASUREMENT IN PROGRESS TAG
- C. SETUP: FACTORY CALIBRATION TAG
- D. CAL: CALIBRATION TAG
- E. PRIMARY DISPLAY  
(DISPLAYS MEASUREMENT AND ERROR MESSAGES)
- F. AUTOMATIC TEMPERATURE COMPENSATION  
(BLINKS WHEN TEMPERATURE EXCEEDS 10-40 °C / 50-104 °F RANGE)
- G. TEMPERATURE UNITS
- H. SECONDARY DISPLAY  
(DISPLAYS TEMPERATURE MEASUREMENTS;  
WHEN BLINKING, TEMPERATURE HAS EXCEEDED OPERATION RANGE: 0-80 °C / 32-176 °F)

## Front Panel

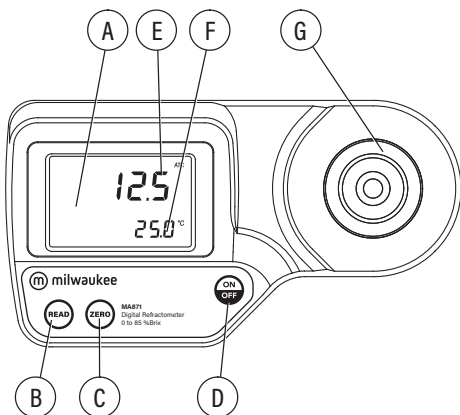

- A. LIQUID CRYSTAL DISPLAY (LCD)
- B. READ KEY (USER MEASUREMENT)
- C. ZERO KEY (USER CALIBRATION)
- D. ON/OFF
- E. PRIMARY DISPLAY
- F. SECONDARY DISPLAY
- G. STAINLESS STEEL SAMPLE WELL AND PRISM

## Bottom

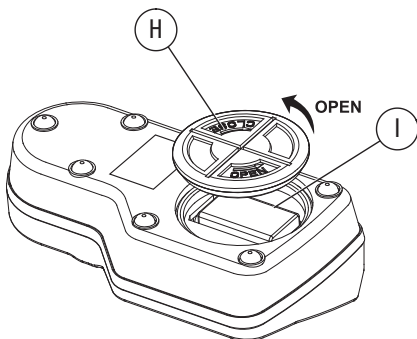

- H. BATTERY COVER
- I. BATTERY COMPARTMENT

## 2. GENERAL DESCRIPTION

### Significance of use

Thank you for choosing Milwaukee. This instruction manual will provide you the necessary information for correct use of the meter.

The **MA871** is an optical instrument that employs the measurement of refractive index to determine the % Brix of sugar in aqueous solutions. The method is both simple and quick. Samples are measured after a simple user calibration with deionized or distilled water. Within seconds the instrument measures the refractive index of the sample and converts it to % Brix concentration units. The **MA871** digital refractometer eliminates the uncertainty associated with mechanical refractometers and is easily portable for measurements in the field.

The measurement technique and temperature compensation employ methodology recommended in the ICUMSA Methods Book (Internationally recognized body for Sugar Analysis).

Temperature (in °C or °F) is displayed simultaneously with the measurement on the large dual level display along with icons for Low Power and other helpful message codes.

Key features include:

- Dual-level LCD
- Automatic Temperature Compensation (ATC)
- Easy setup and storage
- Battery operation with Low Power indicator (BEPS)
- Automatically turns off after 3 minutes of non-use.

Remove the instrument from the packing materials and examine carefully to ensure no damage has occurred during shipping. If any damage has occurred, notify your Dealer.

Each **MA871** instrument is supplied with:

- 9 V battery
- Instruction manual

**Note:** *Save all packing material until you are sure that the instrument functions correctly. A defective instrument must be returned in its original packing.*

### 3. SPECIFICATIONS

Range	0 to 85%	0 to 80 °C (32 to 175 °F)
Resolution	0.1%	0.1 °C (0.1 °F)
Accuracy	± 0.2%	± 0.3 °C (± 0.5 °F)
Light Source	Yellow LED	
Measurement Time	Approximately 1.5 seconds	
Minimum Sample Volume	100 µL (cover prism totally)	
Sample Cell	SS ring and flint glass prism	
Temperature Compensation	Automatic between 10 and 40 °C (50 to 104 °F)	
Case Material	ABS	
Enclosure Rating	IP 65	
Battery Type/Life	1 x 9 volt AA batteries / 5000 readings	
Auto-Shut off	After 3 minutes of non-use	
Dimensions	19.2 x 10.2 x 6.7 cm (7.5 x 4 x 2.6")	
Weight	420 g (14.8 oz.)	

## 4. PRINCIPLE OF OPERATION

The Brix determination is made by measuring the refractive index of a solution. Refractive Index is an optical characteristic of a substance and the number of dissolved particles in it. Refractive Index is defined as the ratio of the speed of light in empty space to the speed of light in the substance. A result of this property is that light will “bend”, or change direction, when it travels through a substance of different refractive index. This is called refraction.

When passing from a material with a higher to lower refractive index, there is a critical angle at which an incoming beam of light can no longer refract, but will instead be reflected off the interface. The critical angle can be used to easily calculate the refractive index according to the equation:

$$\sin(\theta_{\text{critical}}) = n_2 / n_1$$

Where  $n_2$  is the refractive index of the lower-density medium;  $n_1$  is the refractive index of the higher-density medium.

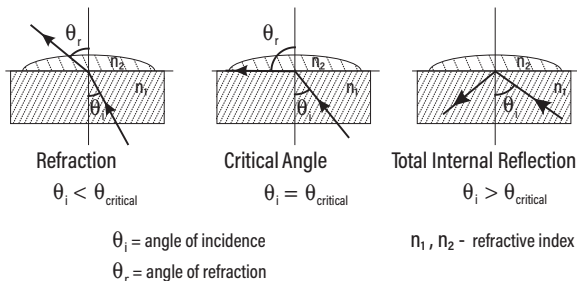

In the **MA871**, light from an LED passes through a prism in contact with the sample. An image sensor determines the critical angle at which the light is no longer refracted through the sample. The **MA871** automatically applies temperature compensation to the measurement and converts the refractive index of the sample to sucrose concentration in units of percent (by weight) Brix.



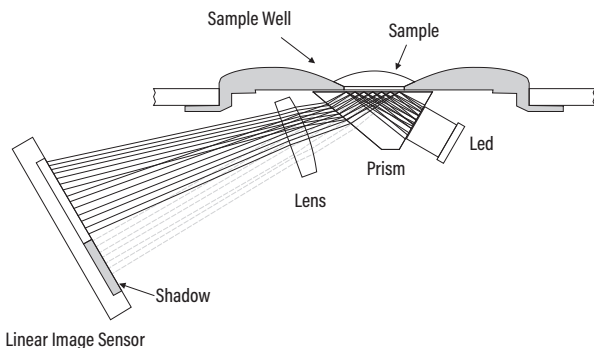

## 5. MEASUREMENT GUIDELINES

- Handle instrument carefully. Do not drop.
- Do not immerse instrument under water.
- Do not spray water to any part of instrument except the "sample well" located over the prism.
- The instrument is intended to measure sugar solutions. Do not expose instrument or prism to solvents that will damage it. This includes most organic solvents and extremely hot or cold solutions.
- Particulate matter in a sample may scratch the prism. Absorb sample with a soft tissue and rinse sample well with deionized or distilled water between samples.
- Use plastic pipettes to transfer all solutions. Do not use metallic tools such as needles, spoons or tweezers as these will scratch the prism.

## 6. CALIBRATION PROCEDURE

Calibration should be performed daily, before measurements are made, when the battery has been replaced, or between a long series of measurements.

1. Press the **ON/OFF** key, then release. Two instrument test screens will be displayed briefly; an "all segment" screen followed by the percentage of remaining battery life. When LCD displays dashes, the instrument is ready.

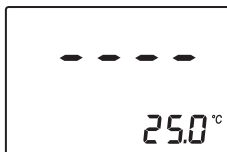
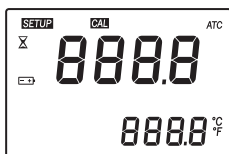

2. Using plastic pipettes, fill the sample well with distilled or deionized water.

**Note:** If the ZERO sample is subject to intense light such as sunlight or another strong source, cover the sample well with your hand or other shade during the calibration.



3. Press the **ZERO** key. If no error messages appear, your unit is calibrated. (For a description of error messages see "ERROR MESSAGES" section).

**Note:** The 0.0 screen will remain until a sample is measured or the power is turned off.

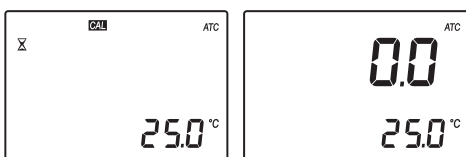

4. Gently absorb the ZERO water standard with a soft tissue. Use care not to scratch the prism surface. Wipe off the surface completely. The instrument is ready for sample measurement.

**Note:** If instrument is turned off the calibration will not be lost.



## 7. MEASUREMENT PROCEDURE

Verify the instrument has been calibrated before taking measurements.

1. Wipe off prism surface located at the bottom of the sample well.



2. Using plastic pipettes, drip sample onto the prism surface. Fill the well completely.



**Note:** If the temperature of the sample differs significantly from the temperature of the instrument, wait approximately 1 minute to allow thermal equilibration.

3. Press the **READ** key. Measurement is displayed in units of % BRIX.

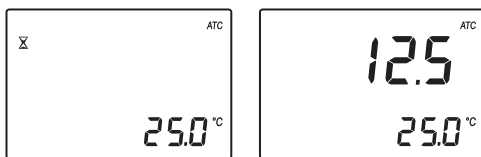

**Note:** The ATC tag blinks and automatic temperature compensation is disabled if the temperature exceeds the 10-40 °C / 50-104 °F range.

4. Remove sample from the sample well by absorbing with a soft tissue.

- Using plastic pipettes, rinse prism and sample well with distilled or deionized water. Wipe dry. The instrument is ready for the next sample.

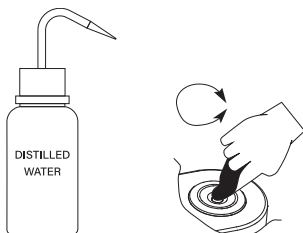

## 8. MAKING A STANDARD % BRIX SOLUTION

To make a Brix Solution, follow the procedure below:

- Place container (such as a glass vial or dropper bottle that has a cover) on an analytical balance.
- Tare the balance.
- To make an X BRIX solution weigh out X grams of high purity Sucrose (CAS #: 57-50-1) directly into the container.
- Add distilled or deionized water to the container so the total weight of the solution is 100g.

**Note:** Solutions above 60% Brix need to be vigorously stirred or shaken and heated in a water bath to roughly 40 °C (104 °F). Remove solution from bath when sucrose has dissolved. Cool completely before use. The total quantity can be scaled proportionally for smaller containers but accuracy may be sacrificed.

Example with 25% Brix:

% Brix	g Sucrose	g Water	Total
25	25.00	75.000	100.000

## 9. CHANGING TEMPERATURE UNIT

To change the temperature measurement unit from Celsius to Fahrenheit (or vice versa), follow this procedure.



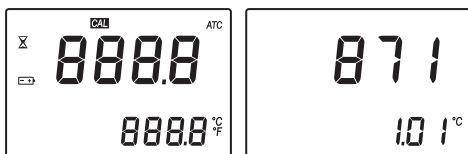

1. Press and hold the **ON/OFF** key continuously for approximately 15 seconds. The LCD will display the "all segment" screen followed by a screen with the model number on the primary display and the version number on the secondary display. Continue pressing the **ON/OFF** key.

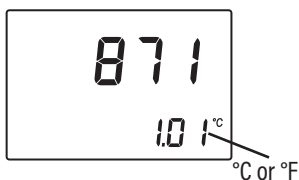

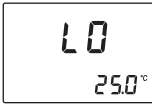

2. While continuing to hold the **ON/OFF** key, press the **ZERO** key. The temperature unit will change from °C to °F or vice versa.

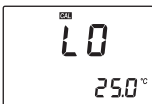
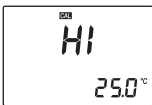
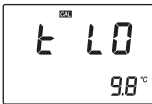
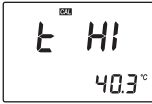
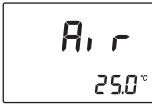

## 10. ERROR MESSAGES

Error Code		Description
Err		General failure. Cycle power to instrument. If instrument still has error, contact Milwaukee.
LO Top display		Sample is reading lower than the 0 % standard used for meter calibration.
HI Top display		Sample exceeds maximum measurement range.
LO Top display CAL segment ON		Wrong calibration used to zero instrument. Use deionized or distilled water. Press Zero.
HI Top display CAL segment ON		Wrong calibration used to zero instrument. Use deionized or distilled water. Press Zero.
t LO Top display CAL segment ON		Temperature exceeds ATC low limit (10 °C) during calibration.
t HI Top display CAL segment ON		Temperature exceeds ATC high limit (40 °C) during calibration.
Air		Prism surface insufficiently covered.
ELt		Too much external light for measurement. Cover sample well with hand.
nLt		LED light is not detected. Contact Milwaukee.

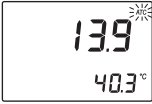
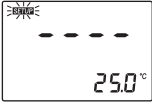
Battery segment blinking		< 5 % of battery life is remaining.
Temperature values are blinking <b>0.0°C</b> or <b>80.0°C</b>	 	Temperature measurement out of sampling range (0.0 to 80.0°C).
ATC segment blinking		Outside temperature compensation range (10 to 40°C).
SETUP segment blinking		Factory calibration lost. Contact Milwaukee.



## 11. BATTERY REPLACEMENT

To replace the instrument's battery, follow these steps:

- Turn the instrument OFF by pressing the **ON/OFF** key.



- Turn instrument upside down and remove the battery cover by turning it counterclockwise.

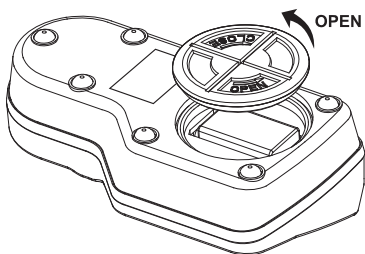

- Extract the battery from its location.
- Replace with fresh 9V battery making certain to observe polarity.
- Insert the back battery cover and fasten it by turning clockwise to engage.

## CERTIFICATION

Milwaukee Instruments conform to the CE European Directives.



**Disposal of Electrical & Electronic Equipment.** Do not treat this product as household waste. Hand it over to the appropriate collection point for the recycling of electrical and electronic equipment.

**Disposal of waste batteries.** This product contains batteries. Do not dispose of them with other household waste. Hand them over to the appropriate collection point for recycling.



Please note: proper product and battery disposal prevents potential negative consequences for human health and the environment. For detailed information, contact your local household waste disposal service or go to [www.milwaukeeinstruments.com](http://www.milwaukeeinstruments.com) (US only) or [www.milwaukeeinst.com](http://www.milwaukeeinst.com).

## RECOMMENDATION

Before using this product, make sure it is entirely suitable for your specific application and for the environment in which it is used. Any modification introduced by the user to the supplied equipment may compromise the meter's performance. For your and the meter's safety do not use or store the meter in hazardous environment. To avoid damage or burn, do not perform any measurement in microwave ovens.

## WARRANTY

This instrument is warranted against defects in materials and manufacturing for a period of 2 years from the date of purchase. Electrodes and Probes are warranted for 6 months. This warranty is limited to repair or free of charge replacement if the instrument cannot be repaired. Damage due to accidents, misuse, tampering or lack of prescribed maintenance is not covered by warranty. If service is required, contact your local Milwaukee Instruments Technical Service. If the repair is not covered by the warranty, you will be notified of the charges incurred. When shipping any meter, make sure it is properly packaged for complete protection.

*Milwaukee Instruments reserves the right to make improvements in design, construction and appearance of its products without advance notice.*

THANK YOU FOR CHOOSING



**Distributor In Australia**

**Pacific Sensor Technologies Pty Ltd.**

Unit 4, 3 Neutron Place, Rowville VIC 3178  
[www.pacificsensortech.com.au](http://www.pacificsensortech.com.au)  
1300 662 720 | [sales@pacificsensortech.com.au](mailto:sales@pacificsensortech.com.au)

Milwaukee Instruments, Inc.  
2950 Business Park Drive  
Rocky Mount, NC 27804 USA  
tel: +1 (252) 443-3630  
fax: +1 (252) 443-1937  
[www.milwaukeeinstruments.com](http://www.milwaukeeinstruments.com)  
e-mail: [sales@milwaukeeinstruments.com](mailto:sales@milwaukeeinstruments.com)

MANMA871