

CONTENTS

TITLE	PAGE
1. Introduction	1
2. Specifications	1
3. Symbol Definition and Button Location	2
4. Operation Instructions	3
4.1 Power-Up.....	3
4.2 Connection the Temperature Probe.....	3
4.3 Selecting the Temperature Scale.....	3
4.4 READ Operation.....	3
4.5 Back light Operation.....	3
4.6 Relative Operation.....	3
4.7 Memory Operation.....	3
4.8 MAX/MIN Operation.....	3
4.9 Auto Power Off.....	4
4.10 Low Battery Condition.....	4
5. Temperature Measurement	4
6. Setting the Time	5
7. Clearing Memory	5
8. Temperature Meter Calibration Setup	6
9. Power Preparation	7
10. Maintenance	7
11. Temperature Probe	8

1. INSTRUCTION

This instrument is a digital thermometer for use with platinum-type temperature sensor. Temperature indication follows IEC751 temperature table for PT-type sensor.

2. SPECIFICATIONS

Numerical Display: 5 digital liquid crystal displays

Measurement Range: -100°C ~ 400°C; -148°F ~ 752°F

Resolution: 0.01°C; 0.02°F;

Sensor types:

Platinum resistance temperature sensor for pt-100 4 wires.

ALPHA=0.00385

Environmental:

- Operating Temperature and Humidity:
0°C ~ 50°C (32°F ~ 122°F) ; 0 ~ 80% RH
- Storage Temperature:
-10°C to 60°C (14°F ~ 140°F); 0 ~ 80% RH
- Altitude up to 2000 meters.

Accuracy: at (23 ± 5°C)

Range	Accuracy
-100°C ~ 400°C	±(0.05% reading + 0.1°C)
-148°F ~ 752°F	±(0.05% reading + 0.2°F)

Temperature Coefficient:

For ambient temperatures from 0°C ~ 18°C and 28°C ~ 50°C, for each °C ambient below 18°C or above 28°C add the following tolerance into the accuracy spec.

0.005% of reading + 0.01°C (0.005% of reading + 0.02°F)

Note:

The basic accuracy Specification does not include the error of the probe please refer to the probe accuracy specification for additional details.

Sample Rate: 2 times per second

Dimension: 185 x 65 x 36 mm(meter only)

Weight: 360g Approx.

Power requirement:

9V Battery;

AC adapter: 9V DC(7~10V Max.)/20mA Min (Plug Diameter: 3.5mmx1.35mm)

Battery Life: Approx. 100hours

Standard Accessory:

Pt-100 Probe(class A), Instruction manual, 9V Battery, carrying case.

Optional Accessories: AC adapter.

3. SYMBOL DEFINITION & BUTTON LOCATION

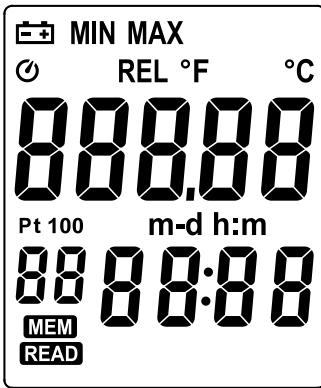

- : The Battery is not sufficient for proper operation.

- MIN** : The Minimum value is now being displayed

- MAX** : The Maximum value is now being displayed

- : This indicates Auto Power Off is enabled.

- REL** : The reading is now under Relative Mode.

- °C °F** : Centigrade and Fahrenheit indication.

- : This indicates that the minus temperature is sensed.

- m-d** : month-day

- h:m** : hours; minute

- MEM** : Readings are being logged.

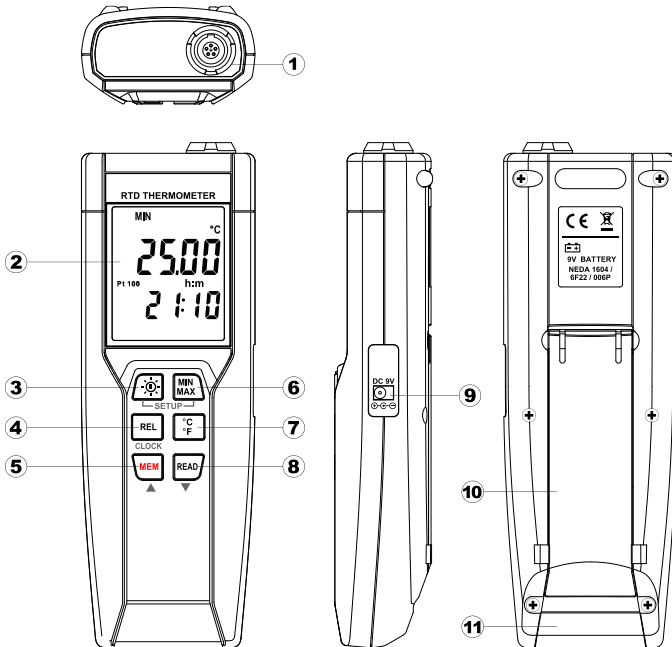

- READ** : Logged readings are display.



- ① Pt type temperature sensor connector
- ② LCD display
- ③ Power ON/OFF and Back light button
- ④ Relative readout button
- ⑤ Memory button
- ⑥ MAX MIN control button
- ⑦ °C , °F control button
- ⑧ Read button
- ⑨ External DC 9V power supply jack
- ⑩ Tilt stand
- ⑪ Battery Compartment

4. OPERATION INSTRUCTIONS

4.1 Power-Up

Press the “” key to turn **ON** the thermometer and Press and hold “” buttons for 3 seconds to **OFF**.

4.2 Connection the Temperature Probe



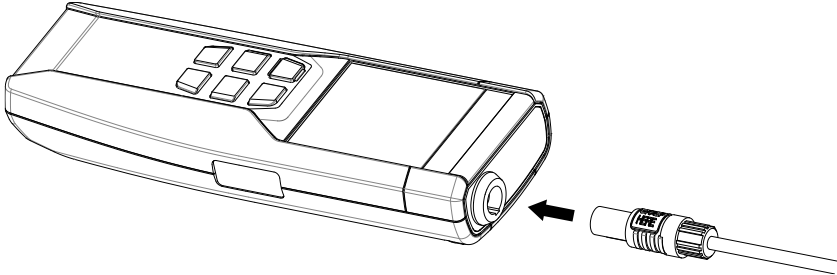



For measurement, plug the temperature probe into the input connectors.





4.3 Selecting the Temperature Scale

When the meter was first power on, the default scale setting is set at Celsius (°C) scale. The user may change it to Fahrenheit (°F) by pressing  button and vice versa to Celsius and change default scale.



4.4 READ Operation

Press  button to view logged readings. The display shows “**READ**”. Press  or  button to scroll through the logged readings. The display shows each logged reading, its time stamp, and its memory location. Press  or  or  any button to exit READ mode.

4.5 Back light Operation:

Press the  button will turn back light on and Press it once again will turn off. The meter will turn back light off if there is no push  button for 30 seconds.

4.6 Relative Operation:

When one press the  button, the meter will memorize the present reading and the difference between the new reading and the memorized data will be shown on the display. Press the  button again to exit the Relative operation.

4.7 Memory Operation:

The thermometer stores a single set of logged readings in memory each time you press  button. The thermometer has 99 memory locations.

4.8 MAX/MIN Operation:

When one press the  button the meter will enter the MAXMIN mode. Under this mode the maximum value, minimum value is kept in the memory simultaneously and updated with every new data.

When the **MAX** symbol is display, the Maximum is shown on the display.

Press  button again, then the **MIN** symbol is on the display and also the minimum reading.

Press $\begin{matrix} \text{MIN} \\ \text{MAX} \end{matrix}$ button again, **MAX** and **MIN** will blink together. This means that all these data is updated in the memory and the reading is the present temperature.

One may press $\begin{matrix} \text{MIN} \\ \text{MAX} \end{matrix}$ to circulate the display mode among these options.

When the meter is under MAXMIN operation, **REL** and $\begin{matrix} ^\circ\text{C} \\ ^\circ\text{F} \end{matrix}$ button are disabled.

To exit the MAX/MIN mode, one may press and hold $\begin{matrix} \text{MIN} \\ \text{MAX} \end{matrix}$ button for two seconds.

4.9 Auto Power Off:

By default, when the meter is powered on, it is under auto power off mode. The meter will power itself off after 30 minutes if no key operation.

One may press and hold **REL** button and then power on the meter and there will be two successive beeps to indicate that auto power off is disabled.

4.10 Low Battery Condition:

The temperature meter low battery indication as follows:

	Low battery. Replace the batteries.
---	-------------------------------------

5. TEMPERATURE MEASUREMENT

5.1 Correct Measurement Method:

The temperature sensor is located at the end of the metal sheath of the sheath type TEMPERATURE PROBE. To accurately test internal temperature insert the probe into the item you want to measure to a distance at least 15 times the diameter of the sheath.

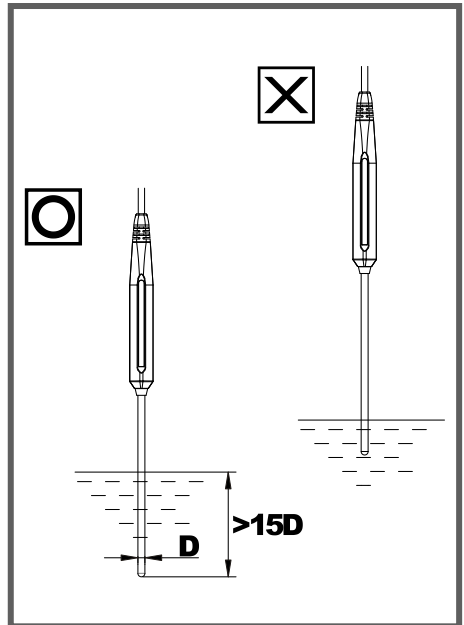

5.2 Connector Configuration:

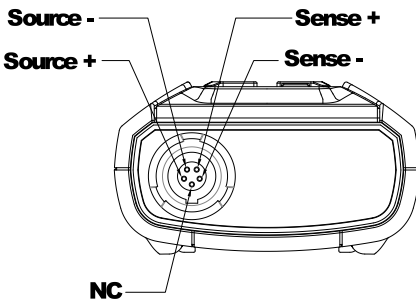

6. SETTING THE TIME

- 6.1 Press and hold $\boxed{\text{MIN}}/\boxed{\text{MAX}}$ button and then power on the meter to enter setup mode.
- 6.2 Press $\boxed{\text{REL}}$ button to enter Time setting mode. The right two digits blink.
- 6.3 Press $\boxed{\text{MEM}}/\blacktriangle$ or $\boxed{\text{READ}}/\blacktriangledown$ button until the display shows the correct **year**, and then press $\boxed{\text{REL}}$ button to select. The left two digits blink.
- 6.4 Press $\boxed{\text{MEM}}/\blacktriangle$ or $\boxed{\text{READ}}/\blacktriangledown$ button until the display shows the correct **month**, and then press $\boxed{\text{REL}}$ button to select. The right two digits blink.
- 6.5 Press $\boxed{\text{MEM}}/\blacktriangle$ or $\boxed{\text{READ}}/\blacktriangledown$ button until the display shows the correct **day**, and then press $\boxed{\text{REL}}$ button to select. The left two digits blink.
- 6.6 Press $\boxed{\text{MEM}}/\blacktriangle$ or $\boxed{\text{READ}}/\blacktriangledown$ button until the display shows the correct **hour** (24-hour format), and then press $\boxed{\text{REL}}$ button to select. The right two digits blink.
- 6.7 Press $\boxed{\text{MEM}}/\blacktriangle$ or $\boxed{\text{READ}}/\blacktriangledown$ button until the display shows the correct **minutes**, and then press $\boxed{\text{REL}}$ button to store the time in memory.

Note:

Holding down "REC" or "C/F" causes the number to change more quickly.

7. CLEARING MEMORY

When memory is full, **MEM** appears and blinks on the display and logging stops.

You can clear memory in next power on the meter to enter clear memory mode.

Press and hold $\boxed{\text{MEM}}$ button and then power on the meter to enter clear memory mode to delete logged readings from memory. The display shows the number from 5 decreases to 0.

8. TEMPERATURE METER CALIBRATION SETUP

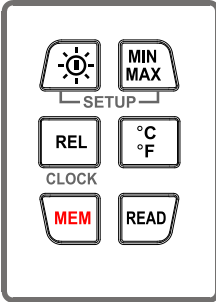

Below table diagram shows each button function when user enter into calibration mode.

Note:

Turn the Power “OFF” before attempting following SETUP.
Setup mode is cancelled during below procedure if “POWER” button is pressed.

8.1 Temperature Calibration

Place the temperature probe in a known, stable temperature environment. Allow the readings to stabilize. In Setup change the offset until the display reading matches the calibration temperature.

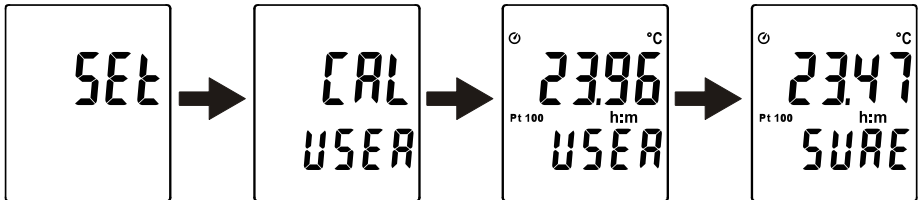

Press and hold **REL** + **°C °F** buttons and then power on the meter to enter setup mode.

Press **READ** button to enter calibration mode.(in 3 seconds)

Press **°C °F** button to enter calibration mode. (in 3 seconds)

Press **MEM** or **READ** button to confirm present Temperature value.

Press **°C °F** button twice to confirm selection.

Note: To abort during the process, press **OFF** button to exit calibration mode.

8.2 Recall Default factory setting value

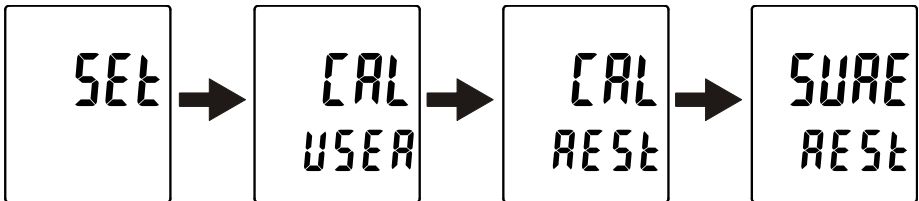



Press and hold **REL** + **°C °F** buttons and then power on the meter to enter setup mode.

Press **READ** button to enter calibration mode. (in 3 seconds)

Press **MIN MAX** button to enter recall mode. (in 3 seconds)

Press  button to confirm revert back to “Default factory setting value”

Press  button to confirm selection.

Note: To abort during the process, press  button to exit calibration mode.

9. POWER PREPARATION

9.1 Battery Loading

Remove the battery cover on the back and insert one 9V battery.

9.2 Battery Replacement

When the battery voltage drops below the operating voltage, Low battery indicator  will appear. Replace a 9 Volt battery immediately to ensure the unit functions properly.

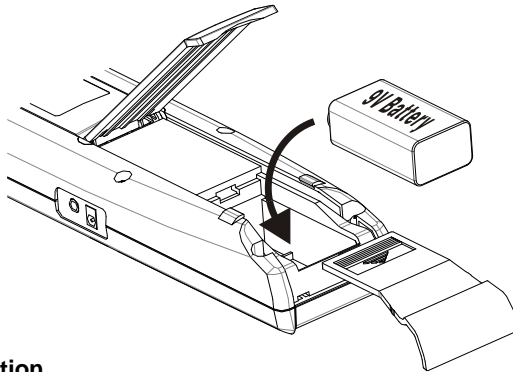

9.3 AC Adapter Connection

When the AC adapter is used, insert the plugs of the adapter into the DC9V connector on the side panel.

Note:

When the AC adapter is connected while battery is inserted, the unit will be powered from the adapter (the AC adapter has priority).

10. Maintenance

In order to ensure the accuracy of the thermometer for a longer period of time you should calibrate it once a year.

Clean the device and the window of the display with a clean, lint-free, antistatic and dry cleaning cloth.

 *Do not use cleaning agents that contain carbon or benzenes, alcohol or anything similar to clean the product since these substances damage the surface of the measuring instrument. Moreover, these fumes are hazardous to health and explosive. Do not use tools with sharp edges, screwdrivers, metal brushes or anything similar to clean the device.*

11. Temperature Probe

11.1 Piercing type temperature probe.

11.2 Piercing type temperature probe Specification:

Sensor Type	Platinum resistance thermometer sensor Pt 100(4 wires)
Accuracy	IEC751, class A $\pm 0.15^{\circ}\text{C} \pm 0.002t$ (t: measurement temperature)
Measurement Range	-100 to 400°C
Temperature Sensor Dimensions	Approx. $\varnothing 5.0\text{mm}(\varnothing 0.2\text{'})$
Temperature Sensor Length	Approx. 230mm(9.05")
Cable Length	Approx. 1500mm(59.0")

