

Possible Eurosafe 60 configurations

Standard load basket

Standard load basket

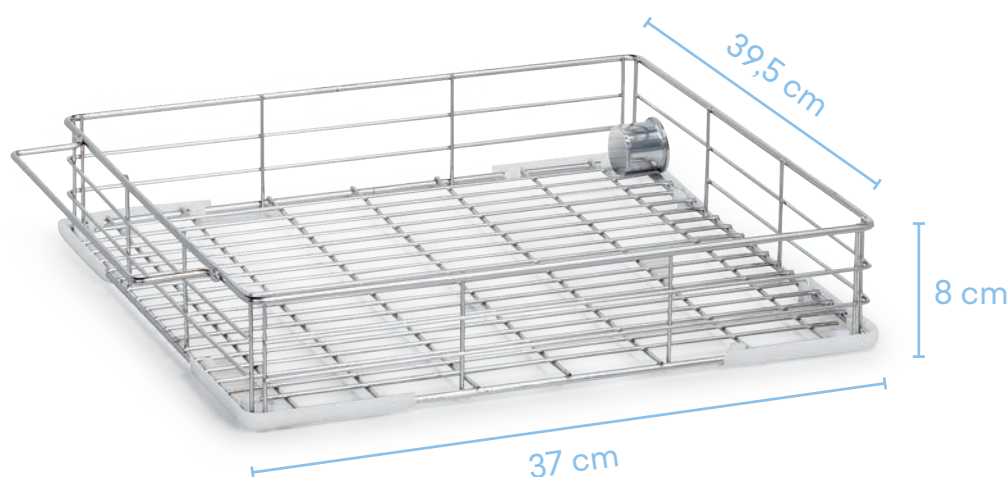

NB

In addition to the configurations shown below, other configurations are possible.

All configurations are indicative and depend on the type of cassettes used, which may vary in size and weight.

Configuration 1

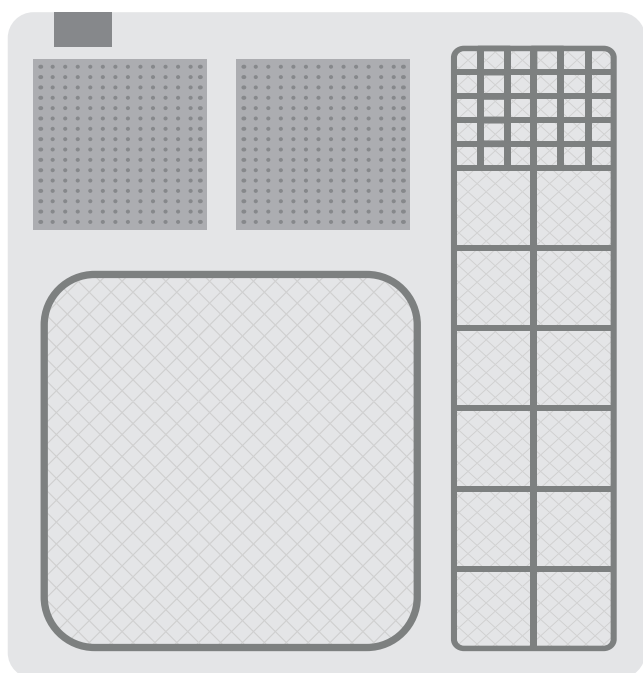

Accessories

- 1 vertical instrument basket
- 1 x ½ DIN basket
- 2 baskets for burs and small parts



Load

- Instruments
- Burs

Possible Eurosafe 60 configurations

Standard load basket

Configuration 2

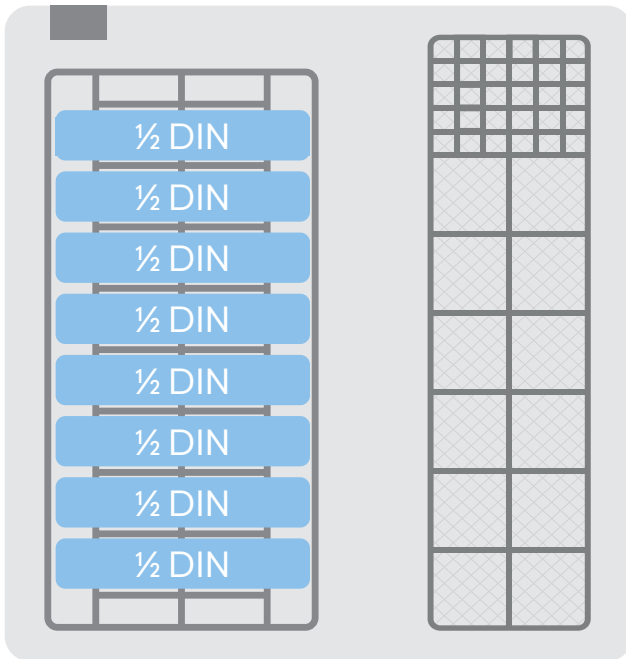

Accessories

- 1 insert with 8 positions
- 1 vertical instrument basket

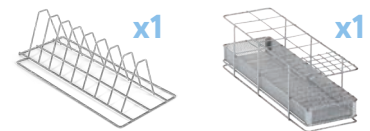

Load

- 8 x 1/2 DIN cassettes (vertical)
- Instruments

Configuration 3

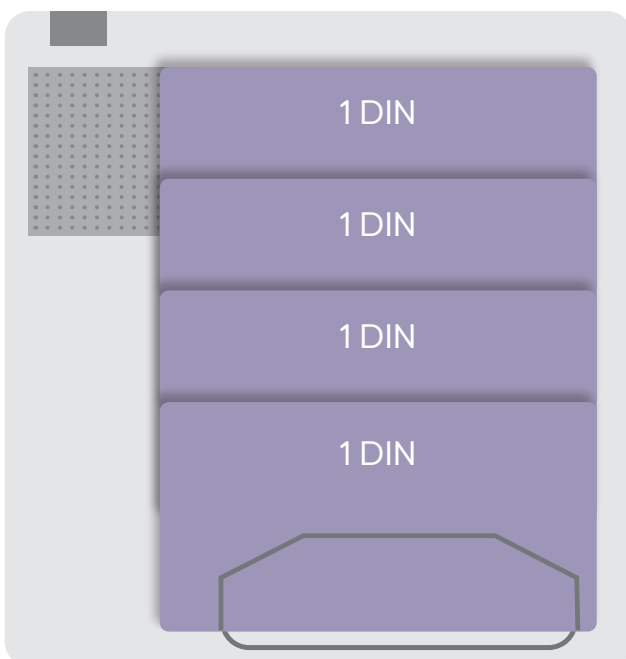

Accessories

- 1 insert with 4 positions
- 1 basket for burs and small parts

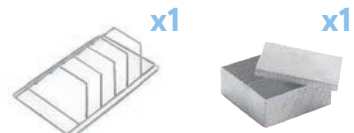

Load

- 4 x 1 DIN baskets
- Burs

Possible Eurosafe 60 configurations

Standard load basket

Configuration 4

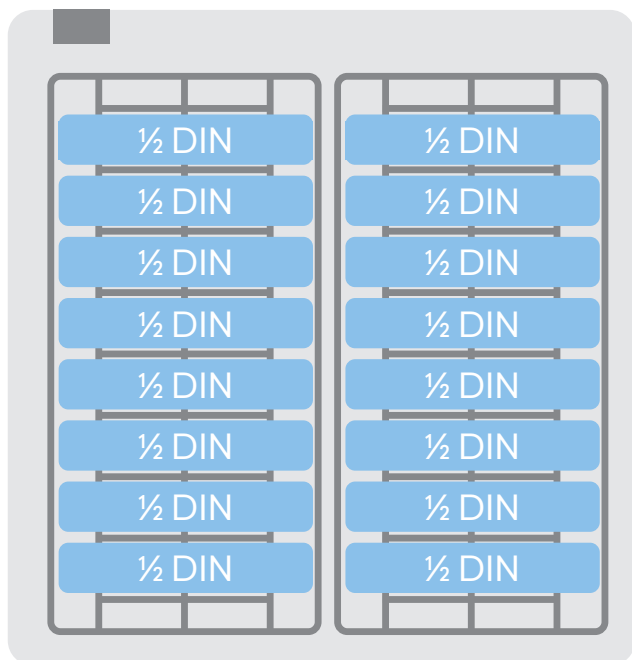

Accessories

- 2 inserts with 8 positions

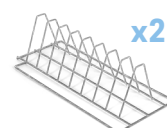

Load

- 16 x 1/2 DIN cassettes (vertical)

Possible Eurosafe 60 configurations

Load basket with handpiece holders

Load basket with handpiece holders

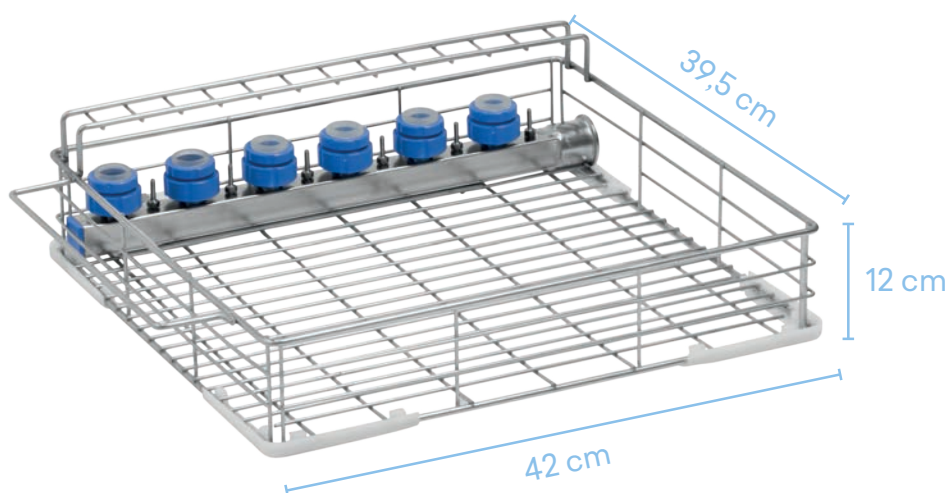

NB

The configurations are valid for all available load basket models with handpiece holders.

In addition to the configurations shown below, other configurations are possible.

All configurations are indicative and depend on the type of cassettes used, which may vary in size and weight.

Available models

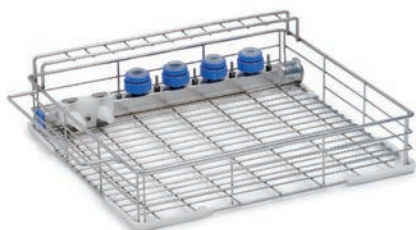

Load basket with 4 supports for handpieces, 5 injectors for hollow items, 2 connections for aspiration tubes



Load basket with 6 handpiece holders and 6 injectors for hollow items



Load basket with 8 handpiece holders

Possible Eurosafe 60 configurations

Load basket with handpiece holders

Configuration 1

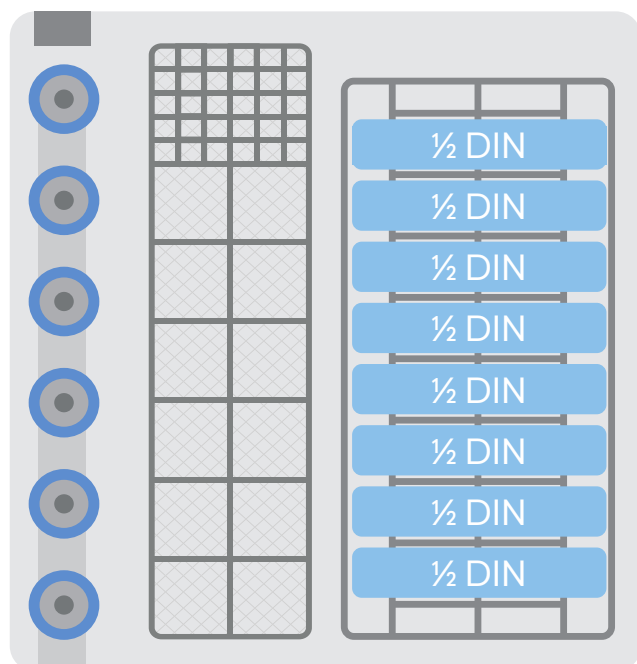

Accessories

- 1 insert with 8 positions
- 1 vertical instrument basket

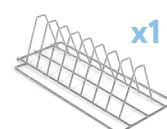

Load

- 8 x 1/2 DIN cassettes (vertical)
- Instruments

Configuration 2

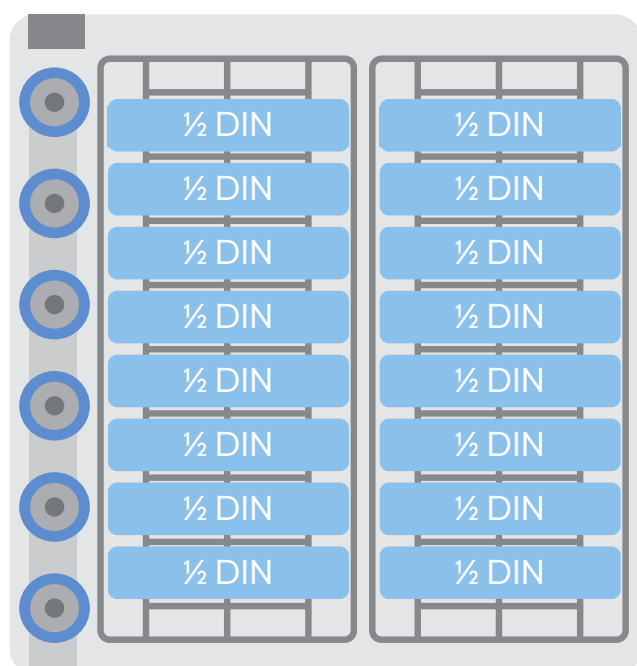

Accessories

- 2 inserts with 8 positions

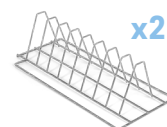

Load

- 16 x 1/2 DIN cassettes (vertical)

Possible Eurosafe 60 configurations

Load basket with handpiece holders

Configuration 3

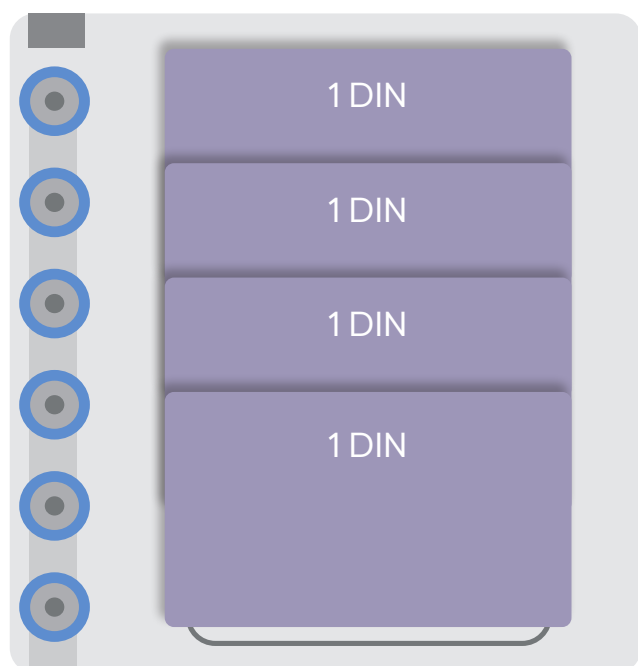

Accessories

- 1 insert with 4 positions

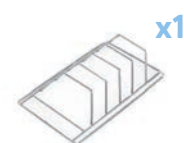

Load

- 4 x 1 DIN baskets

Possible Eurosafe 60 configurations

Compatibility of accessories

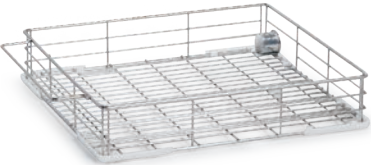
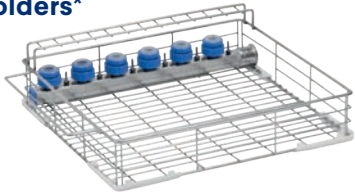
		Standard load basket 	Load basket with handpiece holders* 
1	Basket for burs and small parts	✓	✓
2	½ DIN basket	✓	✓
3	Insert for vertically-positioned instruments	✓	✓
4	8-position insert for trays	✓	✓
5	4-position insert for trays	✓	✓
5	2-position insert for trays	✓	✓
7	Adapters for handpieces	✗	✓
8	Supports for handpieces	✗	✓
9	EasyAdapter Adapters**	✗	✓

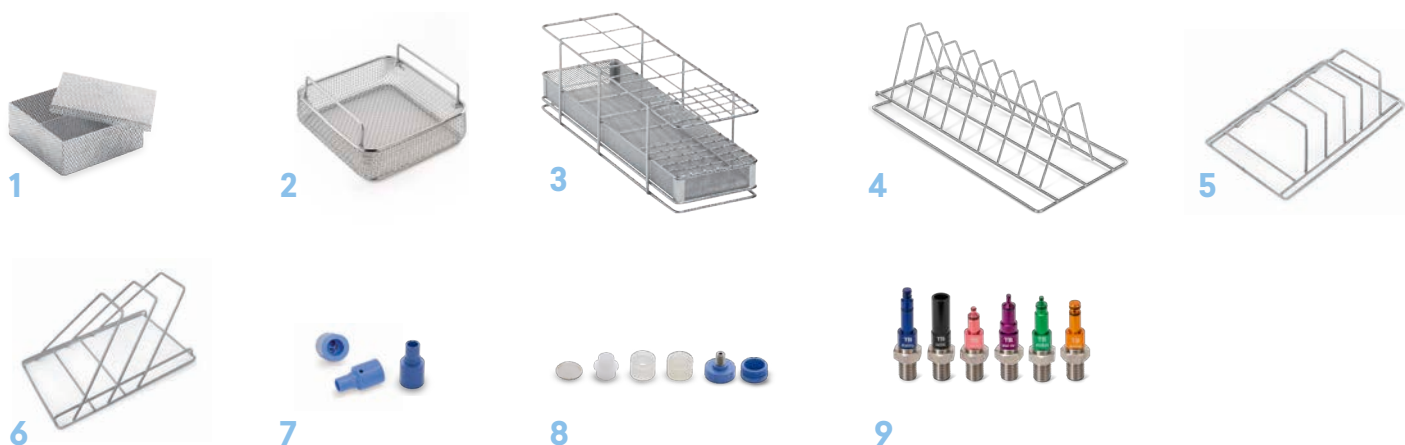

* Accessories are compatible with all available load basket models with handpiece holders.

** Not compatible with the load basket with 8 handpiece holders.