



www.cometsystem.com

Instruction manual

Commeter C3121P

Digital thermometer-hygrometer with external probe
for compressed air measurement

Table of contents

GENERAL DESCRIPTION	3
TECHNICAL PARAMETERS	4
Measured and calculated values	4
General	5
Operation conditions	6
Dimensions	7
OPERATION OF THE DEVICE	8
Switching ON and OFF the device	8
Displaying of actual measured values	8
Function HOLD (storing of actual measured values) and minimum a maximum memory	9
Functions and settings available from menu	9
Alarm indication and setting	11
BATTERY REPLACEMENT	12
TECHNICAL SUPPORT AND SERVICE	13
APPENDIX A	14

General description

Instrument is designed for measurement of temperature and relative humidity with an external probe on a cable with the possibility of displaying the dew point temperature. Measured values are displayed on a dual line LCD display. Temperature is measured by RTD sensor Ni1000/6180ppm. Instrument compares measured values of temperature, humidity and dew point with two adjustable levels for each measured quantity. Breaking the level is indicated by blinking the proper value on display and by audio indication (switchable). Instrument is equipped with minimum and maximum memory and Hold function. Minimum and maximum values and Hold value are possible to display on the LCD anytime.

The sensing element of the device is the external probe designed for compressed air measurement up to 25 bars. It is good to mount probe directly into high pressure area (i.e. air pressured pipe) if it is possible. There is other possibility to use flow chamber SH-PP, see Appendix A.

Technical parameters

Measured and calculated values

Temperature:

Measuring range: -30 to +105 °C
Resolution: 0.1 °C
Accuracy: ± 0.4 °C
Response time: $t_{90} < 9$ min with sensor cover with filter from stainless steel mesh

Air flow approximately 1m/s, temperature step 20 °C

Relative humidity:

Measuring range: 0 to 100 %RH
Resolution: 0.1 %RH
Accuracy: ± 2.5 %RH from 5 to 95 %RH at 23 °C
Response time: $t_{90} < 30$ s with sensor cover with filter from stainless steel mesh

Air flow approximately 1m/s, humidity step 65 %RH, constant temperature

Dew point temperature:

Measuring range: -50 to +80 °C
Resolution: 0.1 °C
Accuracy: ± 1.5 °C at temperature $T < 25$ °C and $RH > 30\%$
(for more details see graphs)

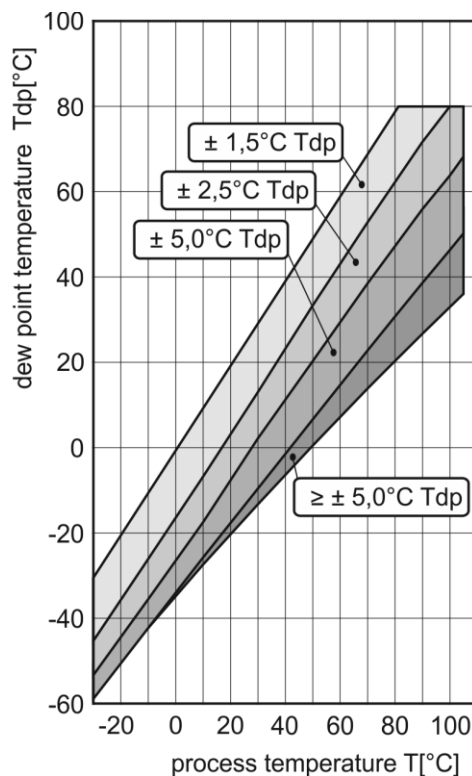
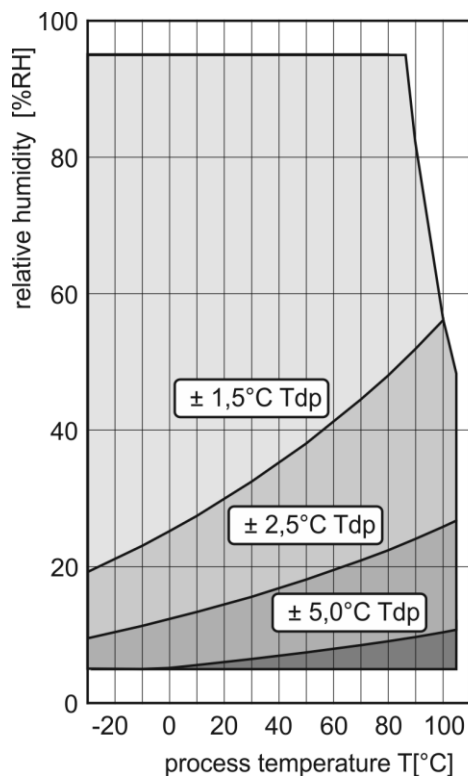

General

Power:

Battery 9V or ac/dc adapter 12 V with NiMH accumulator 9V

If instrument is supplied from external ac/dc adapter, internal 9V battery should be replaced with rechargeable NiMH accumulator. In usual operation from adapter accumulator is charged only with small current. If accumulator is totally discharged, its full charging in instrument takes approximately 100 hours. Instrument with accumulator is not recommended for permanent operation without ac/dc adapter plugged. Accumulator works only as a standby source in case of power mains failure.

Average current consumption:

0.15 to 0.7 mA (depending on operation mode)

Battery life depends on selected display refresh mode (see below). In FAST mode display is refreshed in shortest possible interval with highest current consumption. In dynamic mode display is refreshed in interval up to 5 s in case measured values remain stable. Refresh interval is shortened to approximately 0.7 s only if measured values change. Current consumption in this mode in usual operation is lower, battery life is up to 4 times longer. The FAST mode is recommend to use only in cases, when slower display response is not acceptable.

Battery voltage drop below 7 V is indicated with blinking of "BAT" in default display mode (displaying of actual values) and FAST mode is automatically cancelled to save the battery. At the same time audio indication of alarms is automatically switched OFF.

Measuring interval and display reading refresh approximately:

0.7 s	in FAST mode
0.7 to 5 s	in dynamic mode

Display:

Backlit two-line LCD

Backlighting turns off automatically 10 seconds after the last keystroke

Protection:

IP20 device, sensors are located in cover with IP40 protection

Electromagnetic compatibility:

Device conforms in accordance with EN 61326-1 these norms:

Radiation:	EN 55022	class B
Immunity:	EN 61000-4-2	(levels 4/8 kV, class A)
	EN 61000-4-3	(intensity of electromagnetic field 3 V/m, class B)
	EN 61000-4-4	(levels 1/0.5 kV, class A)
	EN 61000-4-6	(intensity of electromagnetic field 3 V/m, class B)
	EN 61000-4-11	(class A)
	EN 61000-4-5	(class A)

Dimensions:

141 x 71 x 27 mm

Weight:

Approximately 150 g including battery without probe

Material of the probe housing:

Duralumin with the black eloxal surface finish

Operation conditions

Ambient temperature operating range:

-10 to +60 °C, device
-30 to +105 °C, probe

Ambient rel. humidity operating range:

5 to 95 %RH (no condensation), device
0 to 100 %RH, probe

Temperature and rel. humidity restriction:

The measuring range of the external probe is limited in accordance with the graph and must not be exceeded!

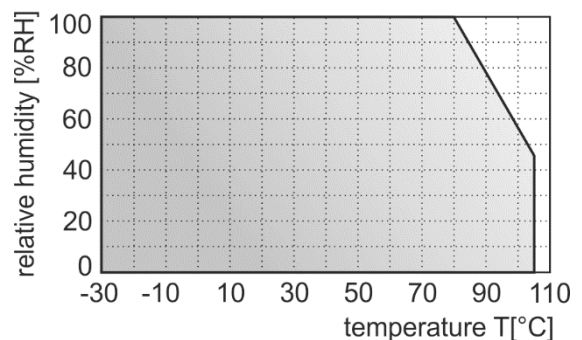
**Operating pressure range of the probe:**

Up to 25 bar

Air flow velocity:

Up to 25 m/s at a pressure of 1 bar (1 m/s at a pressure of 25 bar)

Mechanical connection of probe:

G1/2 with O-ring

Working position of the probe:

Vertical with the cover downwards

Not allowed manipulation:

- It is not allowed to touch the sensors under the cover to prevent damage the sensors.
- The sensors (under the cover) should not be exposed to direct contact with water or other liquids.
- Dismounting of the probe must not be carried out under the pressure.

Dimensions

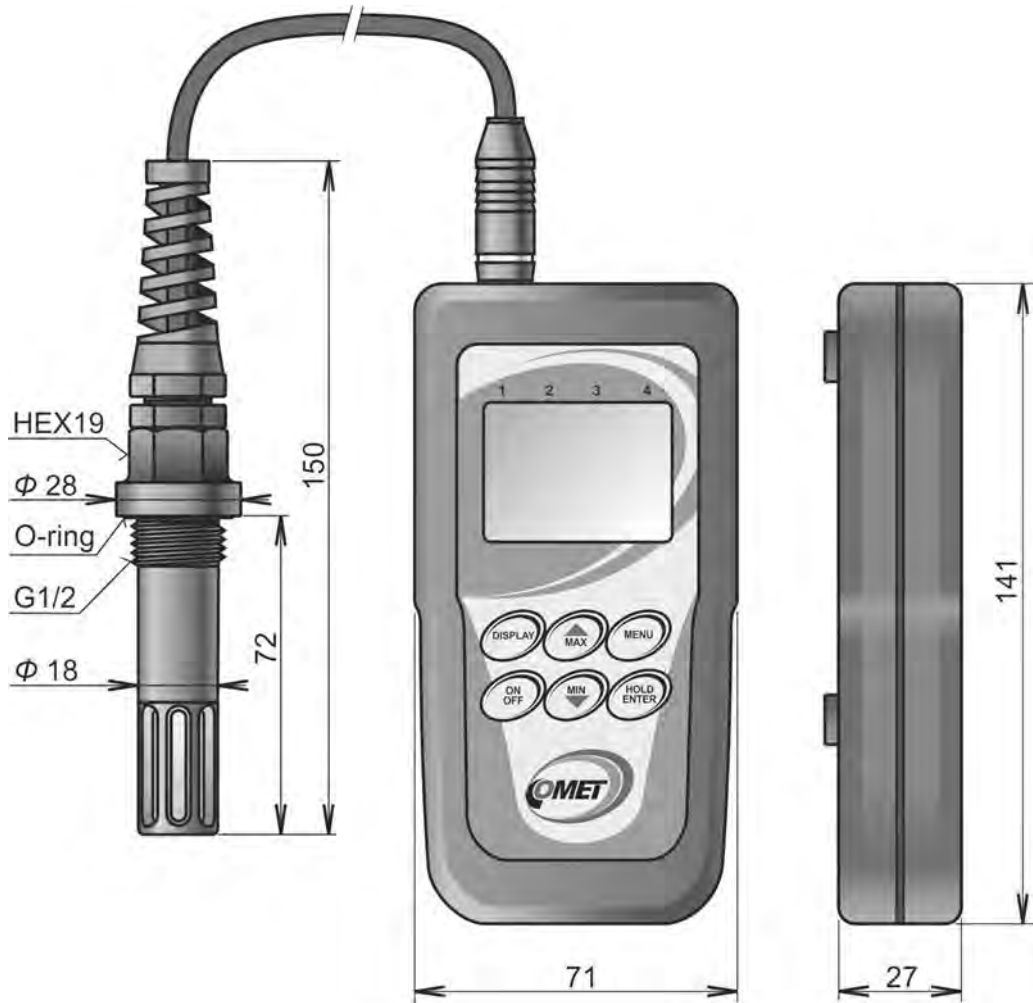

Operation of the device

Switching ON and OFF the device

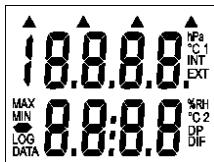

Connect the external probe to the connector before switching ON the instrument. Probe is calibrated with the delivered instrument and it is not possible to replace it with another (if you have several instruments of this type). Switch ON the instrument by pressing ON/OFF key. After switching ON the instrument all symbols on the LCD are displayed. If the ON/OFF key is being held pressed, all LCD symbols are displayed till the key is released.

In usual operation instrument then starts the measurement mode and actual measured values are displayed. If instrument is ON, do not disconnect or connect the probe to prevent storing of incorrect value to minimum and maximum memory.

Displaying of actual measured values

In this mode is instrument anytime after switching ON. It is possible to enter this mode from other modes by pressing or by repeating pressing of MENU key. If the external probe is not connected properly or probe temperature is out of measuring range, reading -- is displayed on the appropriate LCD line.

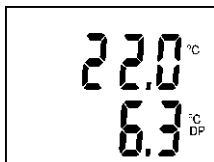
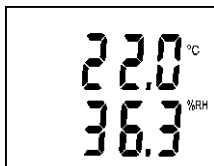

Temperature in °C is displayed on the upper LCD line and relative humidity in %RH is displayed on the lower LCD line.

Press DISPLAY key to display other readings - temperature in °C on upper line and dew point temperature on lower line (°C DP).

Function HOLD (storing of actual measured values) and minimum a maximum memory

Press HOLD key in the default mode (displaying of actual measured value) to store actual measured values to internal memory (indicated by short beep). Anytime it is possible to display stored values from MENU (see below). Each pressing of the HOLD key in the default mode causes values stored in HOLD memory are replaced with actual ones.

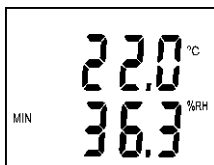

Switched ON instrument permanently updates minimum and maximum memory of each measured values. Press MIN key (resp. MAX key) in the default mode to display minimum (resp. maximum) reading. These minimum and maximum readings are indicated by MIN (MAX) symbols on the LCD. Press DISPLAY key to display minimum (resp. maximum) value of other values. Pressing MIN (MAX) or MENU key again to return to default mode. Minimum and maximum memory is cleared from menu after confirmation selection CLR (see below). Values in HOLD, MIN and MAX memories remain stored even after instrument is switched OFF.

Functions and settings available from menu

Press MENU key to enter mode of viewing menu items one by one. Press arrow keys up and down to list all menu items. Press MENU key again to return to default mode (displaying of actual measured values).

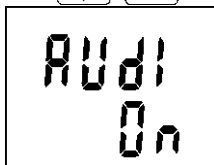

Pressing the ENTER key enables to enter the mode of setting alarm limits for all quantities (see below).

This item indicates if audio signaling of alarm indication is switched on (On) or switched off (OFF). Press ENTER key to change actual setting. Notice: if the battery voltage is low, audio indication is out of operation to reduce current consumption independently on this selection.



Clearing of minimum and maximum memory of all values. Memory is cleared after pressing ENTER key. Clearing is confirmed by reading YES on the LCD lower display.



Press ENTER key to display values stored in the HOLD memory. Press DISPLAY key to display other stored values. Press ENTER key to leave this mode.

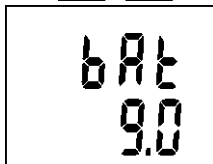

Battery voltage of partially loaded battery is displayed. This value illustrates battery condition.

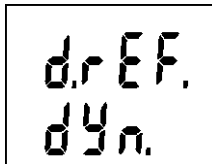
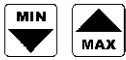

Display refresh mode is indicated. In the FAST mode refreshment is fastest with regular interval approximately 0.7 s. In the dynamic refresh mode (DYN.) each 15 s refresh interval of display is doubled to maximum 5 s if measured values are stable. If measured values change, refresh interval decreases to approximately 0.7 s. This dynamic mode prolongs battery life significantly. Select the desired mode by ENTER key. Notice: if battery voltage is low, the FAST mode is out of operation to reduce current consumption independently on this selection.

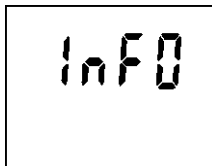

Each pressing of ENTER key causes displaying of service information on software version (upper LCD line) together with instrument configuration on the LCD lower line.

Alarm indication and setting

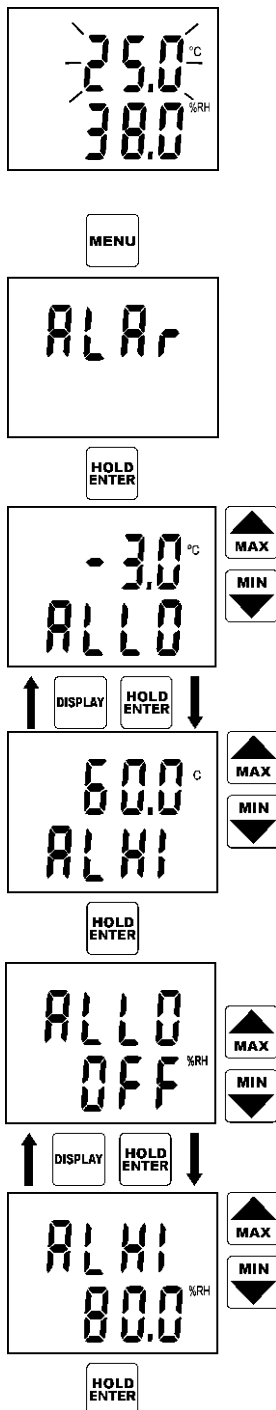

It is possible to set lower and upper limit for each measured quantity. Breaking of the limit is indicated by blinking of the appropriate value on the display. If a new alarm was indicated (i.e. it was not active in the previous measurement), display starts to display the value out of limits. If at least one alarm is active, audio indication can be activated, if menu AUDI "On" is selected (see setting described above). Alarm activation of each value can be disabled by setting lower alarm limit of the desired value up to its maximum. This is indicated by OFF reading at the position of numeric value. Value of upper limit of the same alarm is indifferent.

To set alarms press MENU key, select ALAR from menu items and confirm by pressing ENTER key.

Reading ALLO indicates adjusted lower alarm limit (here air temperature). Set the desired value by means of the arrow keys. Press and hold the arrow key UP to make value increase fast. Press and hold the arrow key DOWN to make value decrease fast. Release the arrow key and press ENTER to confirm new limit.

Reading ALHI indicates adjusted upper limit of the same alarm (here air temperature). Set the desired value in the same way as in above lower limit. If needed it is possible to get back to lower limit setting of the same alarm by pressing DISPLAY key. Press ENTER key to confirm new upper limit.

Then you are offered to set alarm of other input value (here relative humidity). The procedure is the same as the above temperature limit setting. Alarm activation of each value can be disabled by setting lower alarm limit of the desired value up to its maximum. This is indicated by OFF reading at the position of numeric value. Value of upper limit of the same alarm is indifferent.

It is possible to leave the alarm setting mode by pressing MENU key. New adjusted limits up to pressing MENU key are stored in memory.

After pressing ENTER key it is possible to set alarm limits for dew point temperature.

Battery replacement

Low battery voltage is indicated on the display with blinking reading "BAT". It is necessary to replace it with new one as soon as possible. Battery is located under small cover on the instrument lower side. It is absolutely necessary to replace battery with instrument switched OFF, otherwise setting of d.REF. and AUDI (from menu selections) and data in memory HOLD, MIN and MAX will be lost. For the same reason do not disconnect the battery for longer than 1 minute even if instrument is switched OFF. If it happens (or if battery is totally discharged), it is necessary to set again in appropriate menu selection LCD refreshment mode (d.REF.), alarm audio indication (AUDI) and clear the minimum and maximum memory (CLR).

Technical support and service

Technical support and service is provided by distributor. Contact is included in warranty certificate.



Distributor in Australia & New Zealand
Pacific Sensor Technologies Pty Ltd
Unit 4, 3 Neutron Place Rowville, VIC 3178 Australia
1300 662 720 | sales@pacificsensortech.com.au
www.pacificsensortech.com.au

Appendix A

The probe for measuring the moisture of compressed air should be placed directly on the pressure pipelines to achieve higher measurement accuracy and fast response times. But there are cases where such placement is not possible. The reason is the high air speed, high temperature, high pollution, small diameter pipes, etc. Such situation can be solved by placing the probe into the flow measuring chamber. The picture shows the basic layout of the sampling system with flow chamber SH-PP.

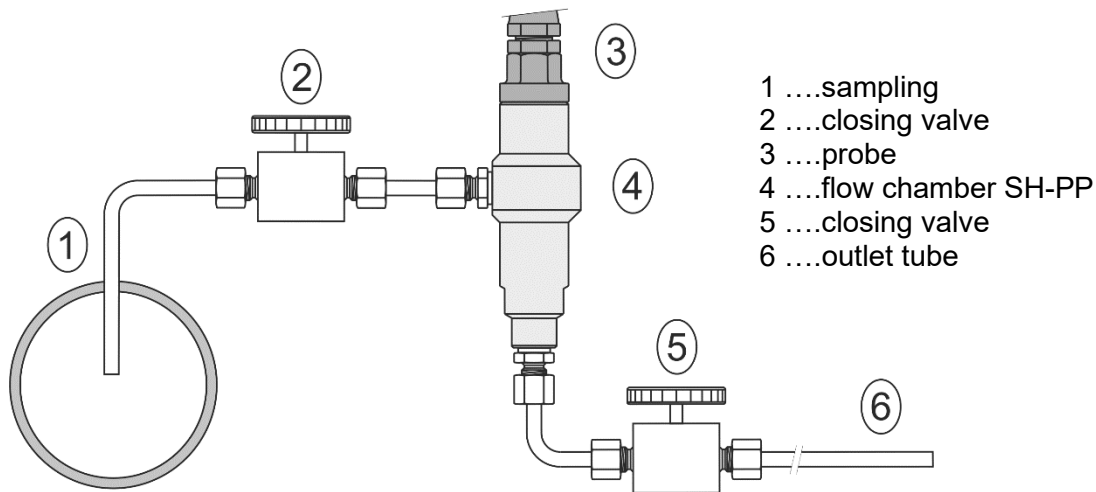

Sampling (1) - end of the tube placed in the centre of pressure pipelines (distribution of moisture in the pipe cross-section is not homogeneous). To achieve fast response times to shorten the length of the sample tubes to a minimum (few meters).

Closing valve (2) - allows access to the sample system without interrupting the main line

Closing valve (5) - the sample flow is regulated by this valve. Measurement accuracy is typically not affected by the sample flow rate, but at low speeds, increasing response time.

Outlet tube (6) - if the measured sample of air is released into the atmosphere, select the length of the outlet tube of 1.5 m (recommended for tube diameter 6mm). The reason is to ensure the accuracy of the sample in the flow chamber and avoid back diffusion of moisture from the ambient air.

Technical specification – flow chamber SH-PP

Material of flow chamber:	stainless steel (DIN 1.4301)
Inlet and outlet connection:	G1/8
Probe connection:	G1/2
Sample flow rate:	0.1 to 3 l/min
Operating pressure:	up to 25 bar
Weight:	580 g

Note: Fittings not included in the delivery

