

PRODUCT DESCRIPTION

Programmable transmitters with 4 – 20mA or 0 - 10V output are designed for measurement of CO₂ concentration in air. Devices can only be used in a chemical non-aggressive environment.

The CO₂ concentration is measured using the dual wavelength NDIR sensor with the multipoint calibration. This principle compensates aging of the sensing elements and offers maintenance free operation and outstanding long term stability.

Measured values are displayed on a two-line LCD display. The device is also equipped with three-color LED for visual indication of the CO₂ concentration. Using *TSensor* software (see www.cometsystem.com) you can set up measuring range of device output, measurement mode of CO₂ concentration and limits of CO₂ LED indication. For device connection to PC is used USB adapter SP003 (optional accessories).

Durable plastic case of the devices contains electronics and connection terminals. For easy connection/disconnection of the output cable use the transmitter in version TxxxxL with plug connector Lumberg instead of the cable gland.

type *	output	measured value	construction	mounting
T5140	4 - 20 mA	CO ₂	ambient air	wall
T5240	0 - 10 V	CO ₂	ambient air	wall
T5141	4 - 20 mA	CO ₂	probe on cable	wall
T5241	0 - 10 V	CO ₂	probe on cable	wall
T5145	4 - 20 mA	CO ₂	duct mount	fix by means of the cable gland
T5245	0 - 10 V	CO ₂	duct mount	fix by means of the cable gland

* models marked TxxxxZ are custom - specified devices

INSTALLATION AND OPERATION

The transmitters T5140 (T5240) and T5141 (T5241) fasten on a flat surface with two screws or bolts. The external CO₂ probe unpack and connect to the T5141 (T5241) device. Then place the probe into the measured environment. The T5145 (T5245) transmitter install by inserting the metal stem into the Pg21 cable gland so that the measured air was fed into the head of device (see *Technical specification*). To fasten the stem it is also possible to use the flange PP4 or PP9 (optional accessory). Pay attention to the mount of the device, because incorrect choice of working position or measuring point could adversely affect accuracy and long-term stability of measured values.

The connecting terminal is accessible after unscrewing the four screws in the corners of the case and removing the lid. Pass the connecting cable through released gland and connect the wires according to diagram. Tighten gland and screw the lid.

For device connection it is recommended to use shielded cable (external diameter 4 to 8mm) with wire cross-section 0.14 to 1.5 mm². Maximum cable length of the current loop is 1200m, maximum voltage output cable length is 15m. For TxxxxL devices it is recommended to use shielded cable (external diameter 3 to 6.5 mm) with wire cross-section max. 0.75 mm². All cables should be located as far as possible from potential interference sources.

The internal test starts after switching the device. During this time (about 20 s) LCD display shows **----** instead of CO₂ concentration value.

Devices **don't** require special operation and maintenance. We recommend you periodic calibration for measurement accuracy validation.

ERROR STATES

Device continuously checks its state during operation and if an error appears, it is displayed relevant code:

Err 2 - CO₂ concentration measurement error occurred, not connected external probe CO2G-10 is indicated as Err4

Err 0, Err 3 and Err 4 - it is a serious error, please contact distributor of the device.

SAFETY INSTRUCTIONS



- **Don't connect** or disconnect transmitter while power supply voltage is on.
- Installation, electrical connection and commissioning should be performed by qualified personnel only.
- Devices contain electronic components, it needs to liquidate them according to legal requirements.
- To complement the information in this data sheet read the manuals and other documentations that are available in the Download section for a particular device at www.cometsystem.com

Technical specifications

4 - 20 mA analog output	Supply voltage	9 - 30 Vdc	T5140	T5141	T5145
	Power consumption / max. power consumption (for 50 ms with 15 s period)	1W / 4W			
0 - 10 V analog output	Supply voltage	15 - 30 Vdc	T5240	T5241	T5245
	Power consumption / max. power consumption (for 50 ms with 15 s period)	0.5W / 3W			
CO ₂ concentration measuring range *			0 to 2000 ppm	0 to 10 000 ppm	0 to 2 000 ppm
Accuracy of CO ₂ concentration measurement at 25°C and 1013 hPa			± (50ppm+2% of measured value)	± (100ppm+5% of measured value)	± (50ppm+2% of measured value)
Temperature dependence of CO ₂ concentration measurement at -20 to 45°C			typ. 2 ppm CO ₂ /°C	± (1+CO ₂ [ppm]/1000) ppm/°C	typ. 2 ppm CO ₂ /°C
Recommended calibration interval			5 years	5 years	5 years
Protection class of the housing with electronics			IP30	IP65	IP65
Protection class of the CO ₂ probe / protection class of the measuring end of stem			— / —	IP65 / —	— / IP20
Temperature operating range of the case with electronics			-30 to +60°C	-30 to +80°C	-30 to +60°C
Temperature operating range of the CO ₂ probe			—	-25 to +60°C	—
Temperature operating range of the measuring end of stem			—	—	-30 to +60°C
Humidity operating range (environment without condensation)			5 to 95%RH	0 to 100%RH	0 to 100%RH
Atmospheric pressure operating range			850 to 1100 hPa	850 to 1100hPa	850 to 1100hPa
Mounting position			850 to 1100 hPa	any position	any position #
Storage temperature range (5 to 95%RH, no condensation, atmospheric pressure 700 to 1100 hPa)			-40 to +60°C	-40 to +60°C	-40 to +60°C
Electromagnetic compatibility according to			EN 61326-1, EN 55011	EN 61326-1, EN 55011	EN 61326-1, EN 55011
Weight			150 g	250 (280, 340) g	260 g
Dimensions [mm]					

Electrical wiring

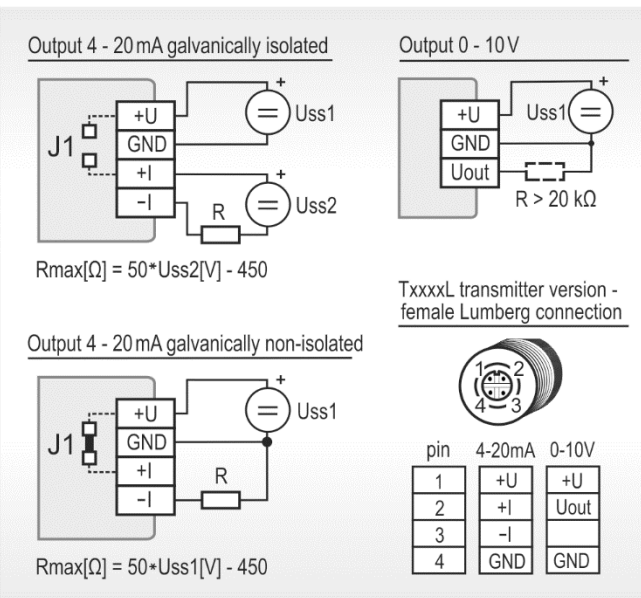

Device with cable gland

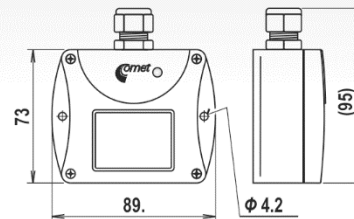

TxxxxL version of device

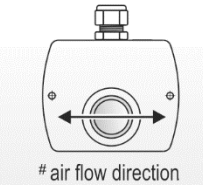
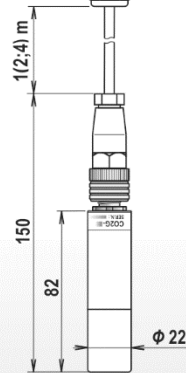
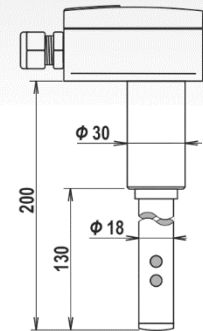
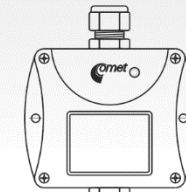
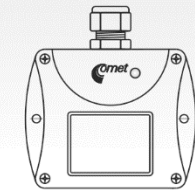
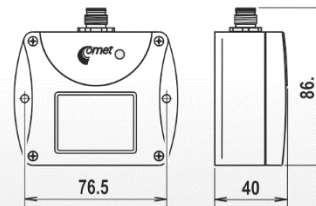

* LED indication (preset by manufacturer): **green** (0 to 1000 ppm), **yellow** (1000 to 1200 ppm), **red** (1200 to 2000/10000 ppm)