



Temperature and humidity regulator

H3060
H3061

Instruction Manual



Table of content

1. GENERAL SAFETY RULES	3
2. GENERAL DESCRIPTION	4
3. REGULATOR MOUNTING AND CONNECTION	4
3.1. Electric installation and safety.....	5
3.2. Device connection	5
4. DESCRIPTION OF DEVICE FUNCTION AND SETTING	6
4.1. Relay outputs	6
4.2. Actual regulator preset	6
4.2.1. Value assigned to output relay.....	6
4.2.2. When close output relay.....	7
4.2.3. Delay.....	7
4.2.4. Hysteresis.....	7
4.3. Regulator setting change	8
4.3.1. Setting with PC and TSensor software.....	8
4.3.2. Setting with using regulator keys.....	8
4.3.3. Extended setting mode	8
4.4. Restore to „Factory default“ – measurement part	12
5. READINGS ON LCD DISPLAY	13
6. DIMENSIONS	13
7. ERROR STATES OF THE DEVICE.....	14
8. TECHNICAL SPECIFICATION	15
8.1. Technical parameters.....	15
8.1.1. Common parameters.....	15
8.1.2. H3060 - temperature and humidity regulator.....	16
8.1.3. H3061(P) - temperature and humidity regulator.....	16
8.1.4. Relative humidity and temperature restriction	17
8.1.5. Value computed from measured relative humidity and temperature.....	17
8.2. Operating conditions	18
8.3. End of operation	19
8.4. Technical support and service	19
9. APPENDIX A.....	20

1. General safety rules

The following summary is designed to prevent injury hazards or device damage. Operate the instrument in accordance with this manual to prevent electric trauma.

Service should be performed by a qualified person only.

Use a safety ac/dc adapter. Use only an adapter with the power voltage recommended by its manufacturer and which is approved by proper standards. Check that the adapter has undamaged cables and cover.

Connect and disconnect correctly. Do not connect and disconnect a LAN cable or lead-in cables if the device is under electric voltage.

Do not use the instrument without the cover.

Do not use the instrument, if it does not work correctly. If the instrument seems not to work correctly, have it checked by a qualified service person.

Do not use the instrument in an explosive environment.

Read instruction manual before the first device connection, please. Regulator version HxxxxP is designed for compressed air measurement up to 25 bars. **Models marked HxxxxZ** are non-standard versions of the devices. Description is not included in this manual.

Copyright: COMET SYSTEM, s.r.o. It is prohibited to copy and edit this instruction manual and make any changes at all without explicit agreement of COMET SYSTEM, s.r.o. All rights reserved.

COMET SYSTEM, s.r.o. makes constant development and improvement of all its products. Manufacturer reserves the right to make technical changes without previous notice. Misprints reserved.

Manufacturer is not responsible for damages caused by using the device in conflict with this manual. To damages caused by using the device in conflict with this manual cannot be provided free repairs during the warranty period.

Contact the manufacturer of this device:

COMET SYSTEM, s.r.o.
Bezrucova 2901
756 61 Roznov pod Radhostem
Czech Republic
www.cometsystem.com



Authorized Distributor in Australia & New Zealand
Pacific Sensor Technologies Pty Ltd
Unit 4, 3 Neutron Place Rowville, VIC 3178 Australia
1300 662 720 | sales@pacificsensortech.com.au
www.pacificsensortech.com.au

2. General description

Regulators of H306x line are designed for online monitoring of temperature in °C or °F and relative humidity of air without aggressive ingredients. Measured temperature and relative humidity are recomputed to following humidity expression: dew point temperature, absolute humidity, specific humidity, mixing ratio and specific enthalpy. The device is equipped with two relay outputs for alarming or controlling of external devices. It is possible to assign any input value to each relay, to set comparing limit, delay, hysteresis and acoustic alarm.

Type	Temperature	Humidity	Computed value	Version
H3060	✓	✓	✓	Outdoor, indoor use.
H3061	✓	✓	✓	Probe with cable
H3061P	✓	✓	✓	Probe for compressed air *)

*) The removable probe for compressed air measurement is noninterchangeable part of the device.
The protection of connector is IP67

Device setting from the manufacturer

If special setting was not required in the order device is set from the manufacturer to the following parameters:

Value assigned to relay 1 and relay 2:	none
Password for setting through keys (PASS):	0000
LCD display:	on
value shown at first LCD line:	temperature
value shown at second LCD line:	relative humidity / dew point temperature
temperature unit:	°C
computed value preset:	dew point temperature
relay response for error:	stay unchanged at previous condition
acoustic alarm:	off

3. Regulator mounting and connection

Regulators are designed for wall mounting. Device must be mounted on the plane surface to prevent its deformation. Mounting holes and connection terminals are accessible after demounting of four screws in the corners of the box and removing the lid. There is recommended to use screws with half round head with cross-recessed screw ST 3.9 (DIN 7981). Lace the lead-in cable with outer diameter of 3 to 6.5 mm through the glands at the case wall and connect them according schematic below. Terminals are self-clamping and can be opened by a suitable screwdriver. For the opening, insert the screwdriver to smaller terminal hole and lever by him. Do not forget to tighten glands and case lid with inserted packing after cables connecting. Insert attached plug into unused cable glands too. Do NOT connect the regulator under voltage.

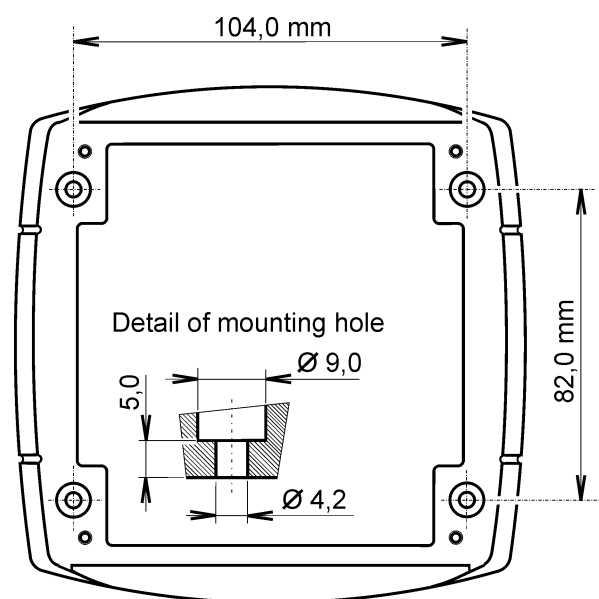

It is NOT recommended to use the device for long time under condensation conditions. It could be the cause of water steam condensation inside the sensor's cover into water phase. This liquid

phase stays inside sensor's cover and can't escape from the cover easily. It can dramatically increase response time to relative humidity change. If water condensation occurs for longer time, it can cause sensor damage. Similar effect can occur under water aerosol conditions.

The device H3061P is designed to measure pressured air. It is good to mount probe directly into high pressure area (i.e. air pressured pipe) if it is possible. There is other possibility to use flow chamber SH-PP, see Appendix A.

Before you remove probe of the transmitter HxxxxP, make sure that the pressure in a pressure chamber (duct, pipe ...) and the ambient pressure are in equilibrium.

3.1. Electric installation and safety

Regulator is designed for the permanent power supply from the electricity – its power lead has to be equipped with accessible cut-off switch (power switch, circuit breaker) and marked as cut-off element of the regulator. Power cable goes thru cable gland in regulator and is has to be connected into the connecting terminals properly. The same should be done with the cables to relay outputs. Cable glands have to be tight in order to avoid of getting a liquid insight the electronics. It also helps to fix the cable to do not pull out the cable from the terminals. Please keep the recommended diameter of the cable!

The electric part of installation should be done by authorized and qualified person in accordance to valid norms.

The regulator has to be disconnected from the power supplying during the installation or any other access into the electronics. The revisal of the device in accordance to local rules and standards has to be done before starting-up. It is strictly recommended to pass the revisal annually due to valid norms.

3.2. Device connection

AC 230V - power supply (110 to 240 VAC)

Normally open contact of relay 1 – when alarm condition is true, contact is closed (LCD shows information about alarm with symbol **ALARM 1**).

Normally closed contact of relay 1 – when alarm condition is true, contact is opened (LCD shows information about alarm with symbol **ALARM 1**).

Normally open contact of relay 2 – when alarm condition is true, contact is closed (LCD shows information about alarm with symbol **ALARM 2**).

Normally closed contact of relay 2 - when alarm condition is true, contact is opened (LCD shows information about alarm with symbol **ALARM 2**).

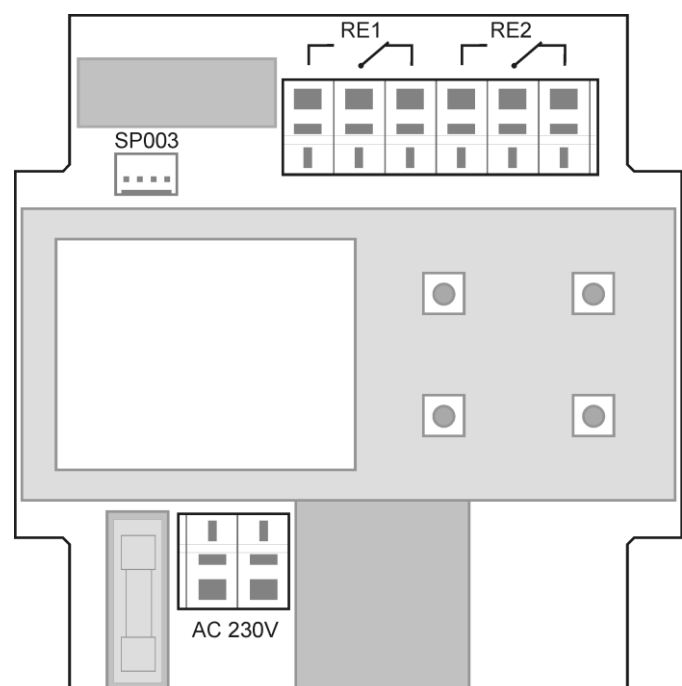

4. Description of device function and setting

4.1. Relay outputs

Regulator is equipped with two relay outputs. It is possible to assign any input or computed value to each relay, to set comparing alarm limit, if the relay may close if measured value is higher (Hi) or lower (Lo) than preset limit, delay for while must be preset condition true before relay close its contact and hysteresis for return to open status. Each relay status is indicated with LED diode and shown on LCD with corresponding symbols „ALARM 1“ or „ALARM 2“.

4.2. Actual regulator preset

It is possible to display actual regulator preset on its LCD display by pressing of „▲“ key. LCD shows information about relay 1 and then relay 2 setting step by step. Information about relay 1 are indicated with symbol „ALARM 1“, for relay 2 with symbol „ALARM 2“ (at right top corner of LCD). It is possible to edit parameters after pressing „SET“ key and entering of correct password „PASS“ – see chapter 4.3.2 at page 8. Following examples are for relay 1 setting, similarly are displayed values for relay 2. Pressing of „ESC“ key ends this mode and switch to actual value displaying, the same occur if more than 20 s is not pressed any key.

4.2.1. Value assigned to output relay

None, relay is still off

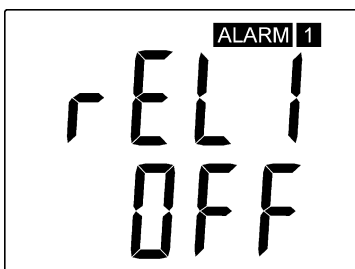

Temperature at °C

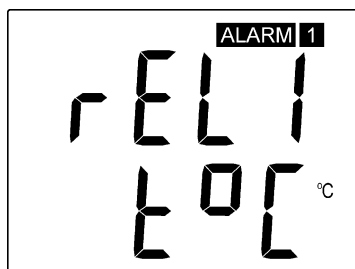

Relative humidity

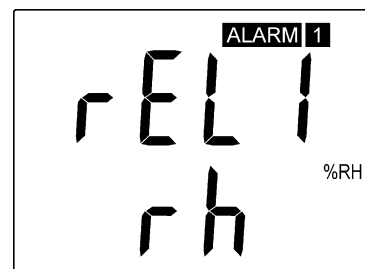

Computed value – dew point temperature

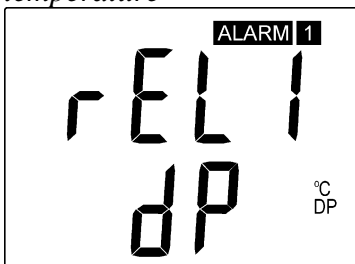

4.2.2. When close output relay

Preset if relay is closed when actual value is higher „HI“ or lower „Lo“ than preset value.

Value higher than 26.5 °C

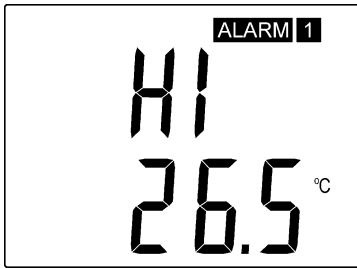

Value lower than 26.5 °C

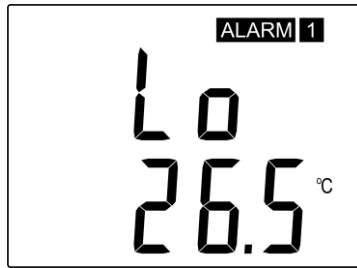

4.2.3. Delay

Time in seconds, when preset condition must be true and after this time output relay is closed (transient reduction of measured value)

Delay in [s]

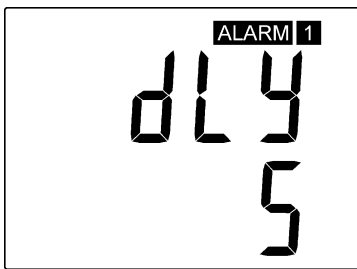

4.2.4. Hysteresis

The amount of measured value which must go under/over preset value to open appropriate output relay. It means if there is condition: relay 1 must be closed if measure value is “higher then” (HI), then measured value must decrease by this value under preset limit to relay output goes open. If condition of relay is: relay 1 must be closed if measured value is “lower than” (Lo), then measured value must be increased by this value over preset limit to relay output goes open.

Preset hysteresis value

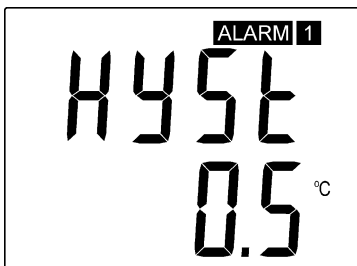

4.3. Regulator setting change

4.3.1. Setting with PC and TSensor software

Device adjustment is performed by means of optional **SP003** communication cable, connected to USB port of PC. When regulator is connected to PC, there is possible to make its setting without external power connection request. At this time output relays will NOT switch, only indication Alarm 1 and Alarm 2 will be right. For correct function of output relays there is necessary to connect external power into range 110 to 240 VAC 50/60 Hz. For setting all parameters of regulator it is necessary to have installed program **TSensor** on the PC. It is free to download at www.cometsystem.com. Follow the program instructions. Regulator includes hardware write protection of internal setting, new setting is possible to write only while:

1. during write period press „SET“ key – do requested setting in TSensor software, press „SET“ key on regulator and keep it down, then click on the button „Save Changes“ into TSensor software and after end of write release „SET“ key, or
2. jumper placed nearby keys is closed (jumper is accessible after demounting of four screws in the corners of the box and removing the lid, don't confuse with jumper nearby Ethernet connector!). This jumper is suitable e.g. until device adjustment is in process and regulator is placed into calibration box and keys are not accessible. Don't forget to remove (open) jumper after procedure finish (restore write protection)

TSensor software supports to make the adjustment of the regulator too. This procedure is described at file „*Calibration manual.pdf*“ which is installed commonly with the software.

4.3.2. Setting with using regulator keys

If „Actual regulator preset“ is displayed, it is possible to enter into edit mode and edit displayed value by pressing „SET“ key. You can edit selected value if right password is entered. During value editing there is range check executed and edited value is still compared with limits for corresponding value (range). If inserted value is higher or lower then edited number is automatically changed to its maximum / minimum value – for possible range see chapter „Technical parameters“ at page 15. Value can be changed with using „▲“ and „▼“ keys. Edited value is switched in “round” -9, -8, -7, ...-2, -1, 0, 1, 2, ...8, 9. To edit next number digit press „SET“ key, for moving back to previous digit press „ESC“ key. Edited value is stored by next „SET“ key pressing. It is possible to cancel editing by pressing „ESC“ key if necessary. If valid password is once inserted right, then there is possible to edit next items without asking for password insertion again, till “Actual regulator preset” is left (till actual measured values are shown). With new entering into edit mode it is necessary to enter Password again. Default password setting is preset from manufacturer to 0000, password change is possible into „Extended setting”. During edit mode regulator still works and changes are valid immediately after its storing – it is NOT necessary to restart regulator.

4.3.3. Extended setting mode

During regulator operation it is possible to change only parameters described in chapter “Actual regulator preset” at page 6. Rest of regulator parameters are available through “Extended setting mode”. **In this mode regulator does NOT communicate, does NOT do any measurements and does NOT service output relays. To leave this mode press „ESC“ key and open jumper nearby keys.**

To enter into Extended setting mode do following steps:

1. disconnect power supply
2. demount four screws in the corners of the box and remove the lid
3. closed jumper placed nearby keys (don't confuse with jumper nearby Ethernet connector)
4. press „▲“ and „▼“ keys together and keep them down
5. connect power supply to regulator – you should see message „SEL“ on the top line of LCD and on the bottom line you should see number of Firmware version (e.g. 0400)
6. release „▲“ and „▼“ keys – you are into “Extended setting mode” now

Use „▲“ and „▼“ keys to inspect each items. If you want to change some shown item then press „SET“ key, item starts blink. Now you can edit setting with using „▲“ and „▼“ keys. To store preset value press „SET“ key. Press „ESC“ key to leave editing (changing) without save – last stored value is kept.

Acoustic alarm assign to relay 1

acoustic indication of relay 1 is OFF

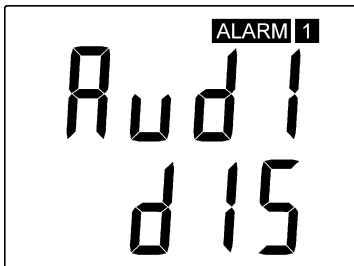

close of relay 1 contact starts acoustic indication

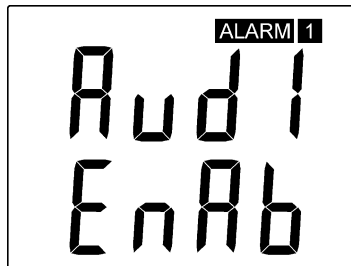

Acoustic alarm assign to relay 2

acoustic indication of relay 2 is OFF

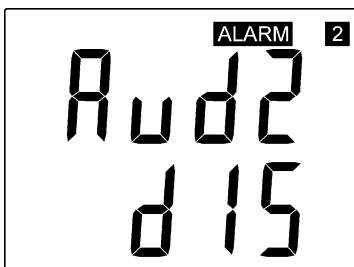

close of relay 2 contact starts acoustic indication

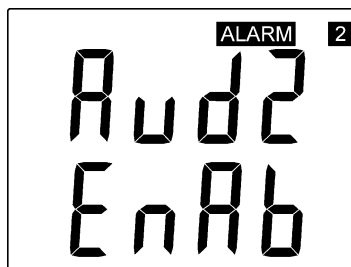

Acoustic alarm deactivation

activated acoustic alarm is possible to deactivate by pressing „ESC“ key

acoustic alarm is still activated for all time and it is impossible to deactivate it

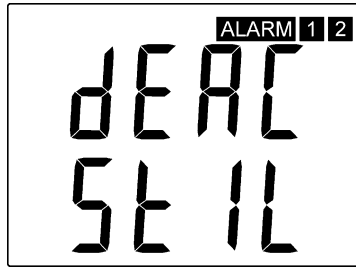
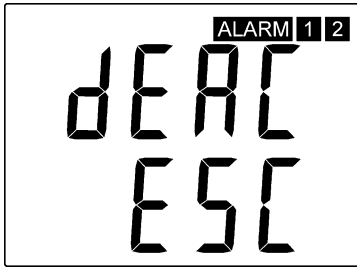

Relay response for error

Regulator continuously checks its state during operation (see chapter “Error States of the device“ at page 14. In case error of assigned value measurement is found then output relay:

stays unchanged (in previous status)



Relay 1 switch OFF



Relay 1 switch On



stays unchanged (in previous status)



Relay 2 switch OFF



Relay 2 switch On



Change of “Password for setting through keys” (PASS)

This item shows actual password setting. It is possible to change it after „SET“ key pressing. It is number from range -19999 to +19999.

password setting

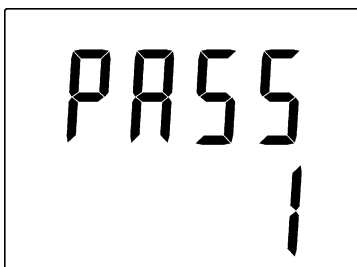

Temperature unit choice

It is possible to measure temperature at °C or °F. There is shown preset unit. It is possible to change it after „SET“ key pressing.

preset to °C

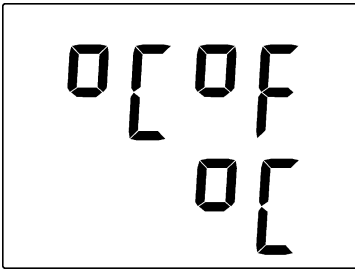

preset to °F

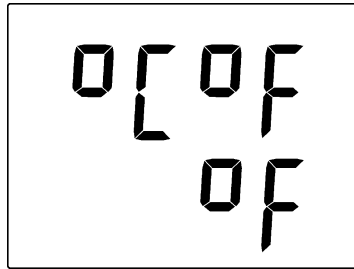

Show temperature at LCD display

This item provides to choice if actual measured temperature may be displayed at LCD display or not. It is possible to change it after „SET“ key pressing.

show value on LCD

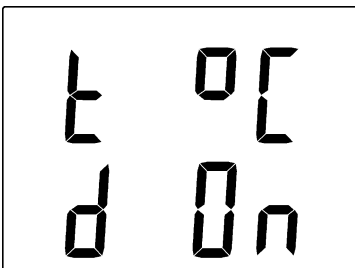

don't show value on LCD

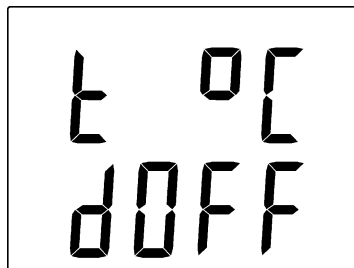

Show relative humidity at LCD display

This item provides to choice if actual measured relative humidity may be displayed at LCD display or not. It is possible to change it after „SET“ key pressing.

show value on LCD

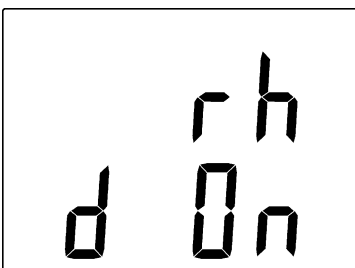

don't show value on LCD

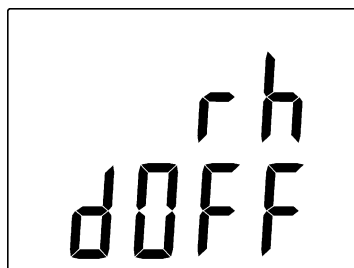

Show computed value at LCD display

This item provides to choice if actual computed value may be displayed at LCD display or not. There is shown the name of computed value on the top LCD line – see “Computed value selection“ below. It is possible to change it after „SET“ key pressing.

show value on LCD

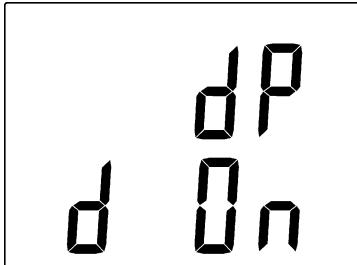

don't show value on LCD

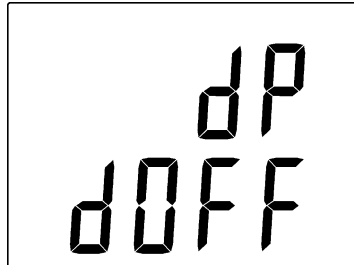

Computed value selection

It shows the actually selected computed value name. It is possible to change it after „SET“ key pressing. There is possible choice one of the following computed values:

dew point temperature

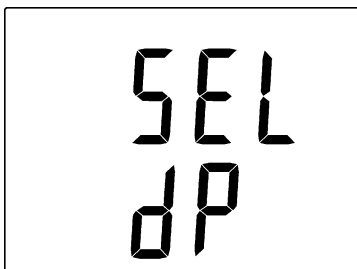

absolute humidity

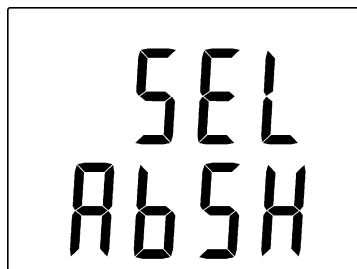

mixing ratio

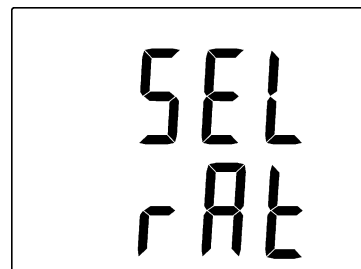

specific humidity

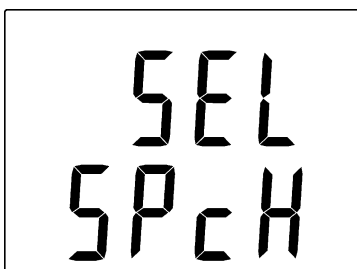

specific enthalpy

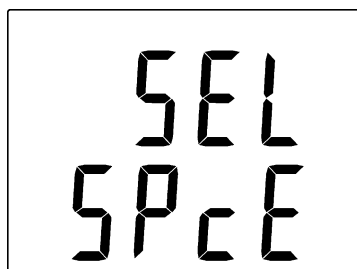

4.4. Restore to „Factory default“ – measurement part

This item provides regulator restoring to factory setting. Press „SET“ key, select „YES“ and confirm it by pressing of „SET“ key. It reset regulator parameters to following values:

Value assigned to relay 1 and relay 2: **none**
Password for setting through keys (PASS): **0000**
display: **on**
temperature unit: **°C**

computed value preset:
 relay response for error:
 acoustic alarm:

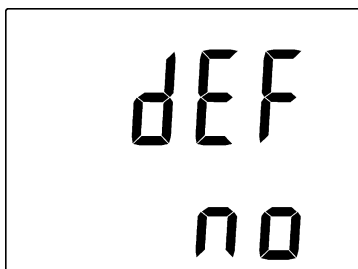

dew point temperature
stay unchanged at previous condition
off
restore to factory default

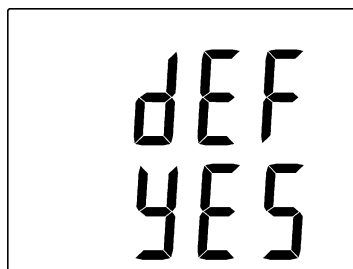

5. Readings on LCD display

°C, °F - reading next to this symbol is measured temperature or error state of value

%RH - reading next to this symbol is measured relative humidity or error state of value

°C / °F DP - reading next to this symbol is calculated dew point temperature or error state of value

g/m³ - reading next to this symbol is calculated absolute humidity or error state of value

g/kg - reading next to this symbol is calculated specific humidity or mixing ratio (depends on device setting) or error state of value

If specific enthalpy is selected, there is shown only value (number) without corresponding unit

3 - this symbol is on if jumper is closed

6. Dimensions

H3060

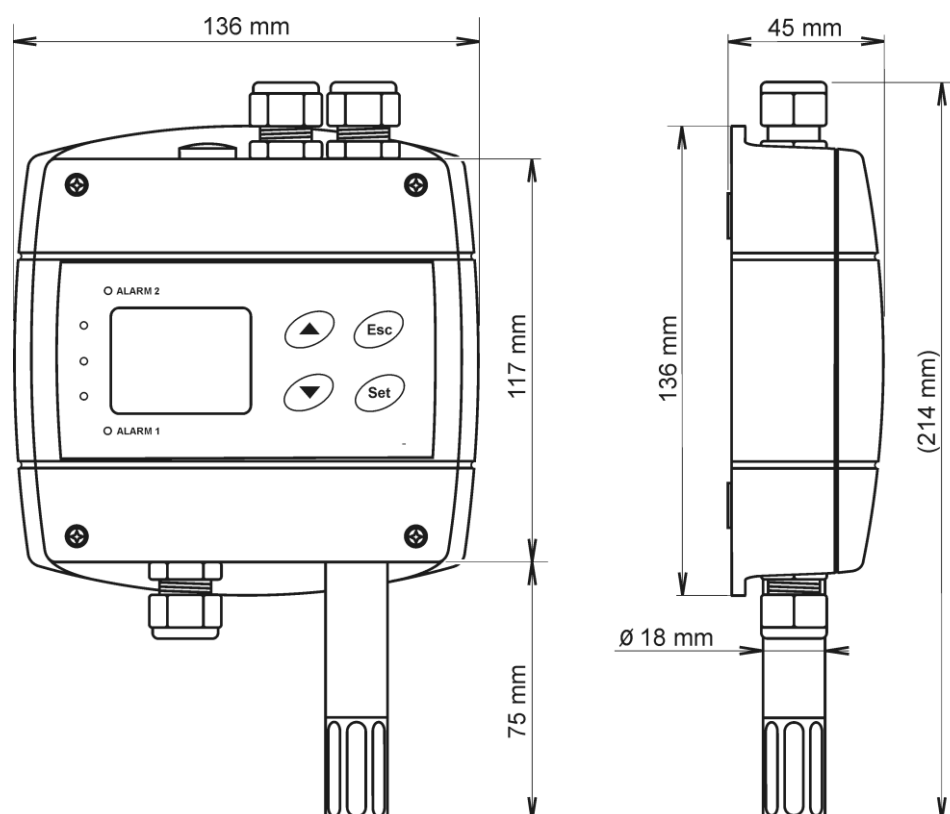

H3061(P)

Probe for compressed air measurement

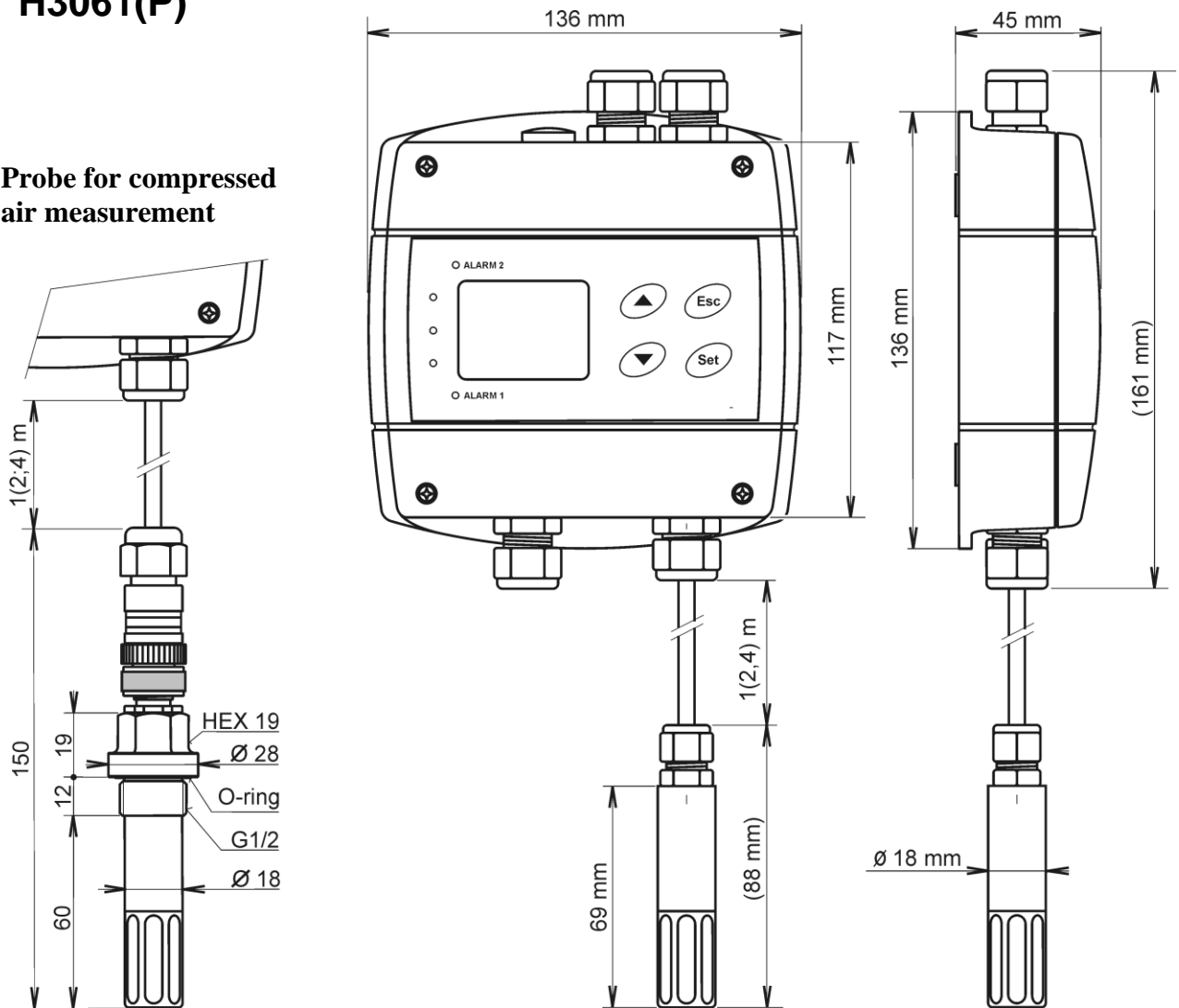

7. Error States of the device

Device continuously checks its state during operation. In case error is found LCD displays corresponding error code:

Error 0

First line of LCD displays „Err0“. Check sum error of stored setting inside device’s memory. This error appears if incorrect writing procedure to device’s memory occurred or if damage of calibration data appeared. At this state device does not measure and calculate values. It is a serious error, contact distributor of the device to fix.

Error 1

Measured or calculated value is over upper limit of allowed full scale range. There is a reading „Err1“ on LCD display. This state appears in case of:

- Measured temperature is higher than approximately 600°C (i.e. high non-measurable resistance of temperature sensor, probably opened circuit).

- Relative humidity is higher than 100%, i.e. damaged humidity sensor, or humidity calculation of humidity is not possible (due to error during temperature measurement).
- Computed value – calculation of the value is not possible (error during measurement of temperature or relative humidity or value is over range).

Error 2

There is a reading „Err2“ on LCD display. Measured or calculated value is below lower limit of allowed full scale range. This state appears in case of:

- Measured temperature is lower than approximately -210°C (i.e. low resistance of temperature sensor, probably short circuit).
- Relative humidity is lower than 0%, i.e. damaged sensor for measurement of relative humidity, or calculation of humidity is not possible (due to error during temperature measurement).
- Computed value – calculation of computed value is not possible (error during measurement of temperature or relative humidity).

Error 3

There is a reading „Err3“ on LCD display upper line. Error of internal A/D converter appeared (converter does not respond, probably damage of A/D converter). Values are NOT measured. It is a serious error, contact distributor of the device.

Error 5, 6

There is problem with assigned value to output relay, there is some wrong setting (mismatch). This error appears if incorrect writing procedure to device’s memory occurred.

Error 9

Inserted password is not valid. Try to insert password again. If you forgot the password see chapter Change of “Password for setting through keys” (PASS) at page 10.

8. Technical specification

8.1. Technical parameters

8.1.1. Common parameters

Power voltage:	110 – 240 VAC, 50 – 60 Hz
Power consumption:	115 VAC max. 120 mA 230 VAC max. 70 mA
Internal fuse:	5 x 20 mm, max. T 1,25A
Measuring interval:	0,5 s
Display switching interval:	4 s (when more than two values are displayed)
Protection:	electronics IP65, sensors are located in cover with IP40 protection
Relay outputs:	
Amount:	2
Max. switching voltage:	250 V
Max. switching current:	8A
Max. switching power:	2000 VA/AC, 192 W/DC

Rated current (resistive load): 8A 250V AC or 8A 24V DC
Insulation resistance (at 500V DC): min. 1000 Mohm
Test voltage (1 min.): open contact 1000V AC, coil / contact 5000V AC
Mechanical life: min. 2×10^7 cycles
Expected life (rated condition) min. 1×10^5 cycles

EMC: EN 61326-1, EN 55011, EN 61000-3-2, EN 61000-3-3

Electrical safety: EN 61010-1

8.1.2. H3060 - temperature and humidity regulator

Temperature:

Accuracy: $\pm 0,4 \text{ }^\circ\text{C}$ ($\pm 0,7 \text{ }^\circ\text{F}$)
Range: -30 to +80 $^\circ\text{C}$ (-22 to 176 $^\circ\text{F}$)
Resolution: 0,1 $^\circ\text{C}$ (0,2 $^\circ\text{F}$)

Relative humidity:

Accuracy: $\pm 2,5 \text{ \%RH}$ from 5 to 95 \%RH at 23 $^\circ\text{C}$ (73,4 $^\circ\text{F}$)
Range: 0 to 100 \%RH
Resolution: 0,1 \%RH

Measuring temperature and humidity range is limited in accordance with the graph below!

Response time (air flow approximately 1 m/s):

temperature: $t_{90} < 7 \text{ min}$ (temperature step 20 $^\circ\text{C}$ (36 $^\circ\text{F}$)) with stainless steel mesh sensor cover (F5200)
 $t_{90} < 9 \text{ min}$ with bronze sensor cover (F0000 - selectable option)
relative humidity: $t_{90} < 30 \text{ s}$ (humidity step 65 \%RH , constant temperature)

8.1.3. H3061(P) - temperature and humidity regulator

Temperature:

Accuracy: $\pm 0,4 \text{ }^\circ\text{C}$ ($\pm 0,7 \text{ }^\circ\text{F}$)
Range: -30 to +105 $^\circ\text{C}$ (-22 to 221 $^\circ\text{F}$), includes probe cable
Resolution: 0,1 $^\circ\text{C}$ (0,2 $^\circ\text{F}$)

Relative humidity:

Accuracy: $\pm 2,5 \text{ \%RH}$ from 5 to 95 \%RH at 23 $^\circ\text{C}$ (73,4 $^\circ\text{F}$)
Range: 0 to 100 \%RH
Resolution: 0,1 \%RH

Measuring temperature and humidity range is limited in accordance with the graph below!

Response time with stainless steel mesh sensor cover (F5200B) and bronze sensor cover (F0000 - selectable option), air flow approximately 1 m/s:

temperature: T3061 $t_{90} < 6 \text{ min}$ (temperature step 20 $^\circ\text{C}$ (36 $^\circ\text{F}$))
T3061P $t_{90} < 16 \text{ min}$ (temperature step 20 $^\circ\text{C}$ (36 $^\circ\text{F}$))
relative humidity: $t_{90} < 30 \text{ s}$ (humidity step 65 \%RH , constant temperature)

8.1.4. Relative humidity and temperature restriction

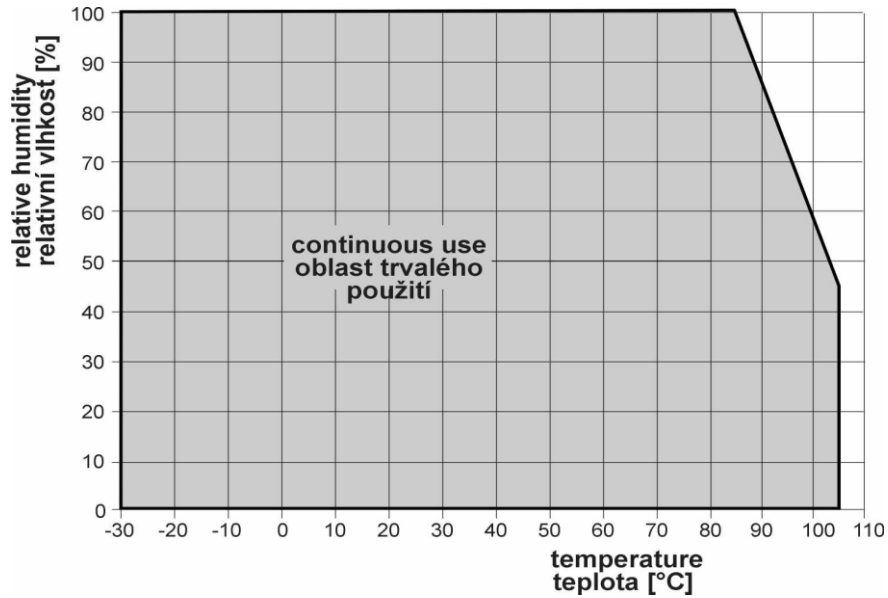

8.1.5. Value computed from measured relative humidity and temperature

Dew point temperature

Range: -60 to +80 °C (-76 to 176 °F)

Accuracy: $\pm 1,5^{\circ}\text{C}$ ($\pm 2,7^{\circ}\text{F}$) at ambient temperature $T < 25^{\circ}\text{C}$ (77°F) and relative humidity $\text{RH} > 30\%$, for more details see graphs below

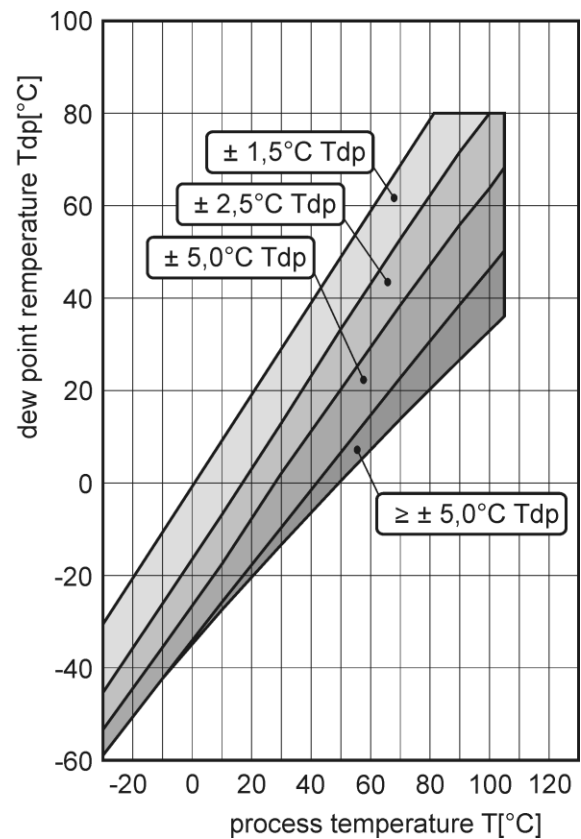
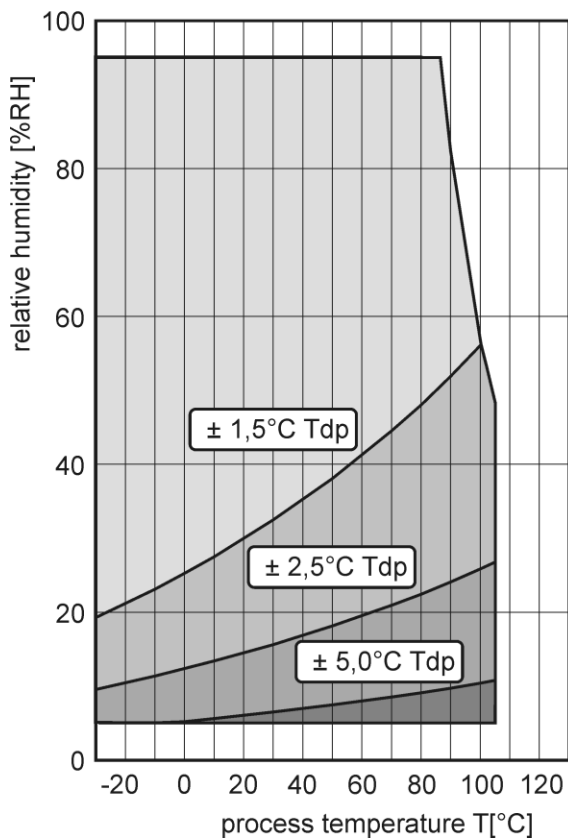

Absolute humidity

Range: 0 to 400 g/m^3

Accuracy: $\pm 1,5 \text{ g/m}^3$ at ambient temperature $T < 25^\circ\text{C}$ (104°F), for more details see graph below

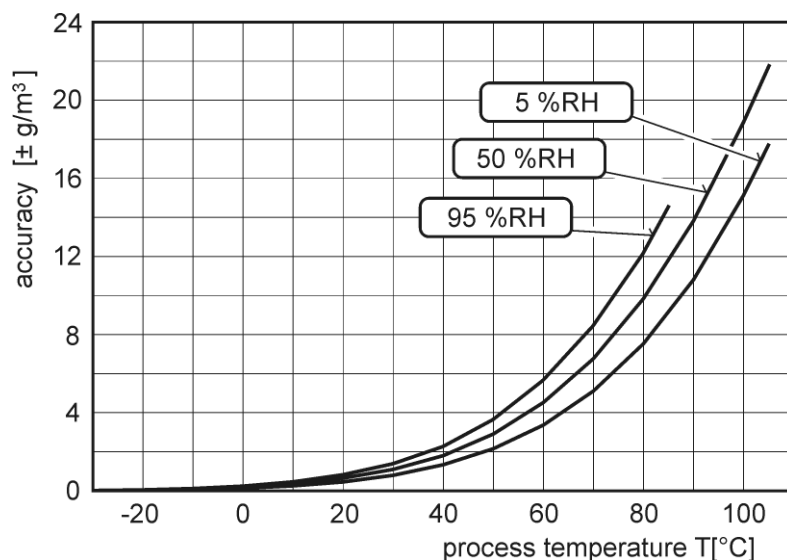

Specific humidity¹

Accuracy: $\pm 2 \text{ g/kg}$ at ambient temperature $T < 35^\circ\text{C}$ (95°F)

Range: 0 to 550 g/kg

Mixing ratio¹

Accuracy: $\pm 2 \text{ g/kg}$ at ambient temperature $T < 35^\circ\text{C}$ (95°F)

Range: 0 to 995 g/kg

Specific enthalpy¹

Accuracy: $\pm 3 \text{ kJ/kg}$ at ambient temperature $T < 25^\circ\text{C}$ (77°F)

Range: 0 to 995 kJ/kg ²

8.2. Operating conditions

Operating temperature and relative humidity:

electronics : -25 to $+80^\circ\text{C}$ (-13 to 176°F), 0 to 100 % RH (without condensation)

probe H3060: -30 to 80°C (-22 to 176°F) , 0 to 100 %RH

H3061(P): -30 to $+105^\circ\text{C}$ (-22 to 221°F) probe cable included, 0 to 100 %RH

It is recommended to switch off the LCD display at ambient temperature above 70°C (158°F) – around electronics

Operating pressure range of probe H3061P: up to 25 bar

Air flow velocity (H3061P probe): up to 25 m/s at a pressure of 1bar (1m/s at a pressure of 25 bar)

¹ This value depends on the atmospheric pressure. For computing is used constant value stored in device memory. Default value preset by manufacturer is 1013hPa and can be changed by user's software.

² This maximum is reached under conditions about $70^\circ\text{C}/100\%RH$ or $80^\circ\text{C}/70\%RH$

Outer characteristics in accordance with Czech National Standard 33-2000-3:

Normal environment with the specifications: AE1, AN1, AR1, BE1

Working position:

H3061(P) negligible
H3060 with sensor cover downwards

Mechanical connection of probe H3061P: G1/2 with O-ring

Not allowed manipulations: It is not allowed to operate the device under conditions other than specified in technical parameters. Devices are not designed for locations with chemically aggressive environment. Temperature and humidity sensors must not be exposed to direct contact with water or other liquids. It is not allowed to remove the sensor cover to avoid any mechanical damage of the sensors.

Storing conditions: temperature -30 to +80 °C (-22 to +176 °F), humidity 0 to 100 %RH without condensation

Dimensions: see dimensional drawings

Weight: approximately:

H3060	390g		
H3061/1m probe	450g,	H3061P/1m probe	490g,
H3061/2m probe	490g,	H3061P/2m probe	530g,
H3061/4m probe	570g	H3061P/4m probe	610g

Material of the case: ASA

Material of the probe H3061P: duralumin with the black eloxal surface finish

8.3. End of operation

Disconnect the device and dispose it according to current legislation for dealing with electronic equipment.

8.4. Technical support and service

The adjustment procedure is described at file „*Calibration manual.pdf*“ which is installed commonly with the TSensor software.

Technical support and service is provided by distributor. For contact see warranty certificate. You can use discussion forum at web address: <http://www.forum.cometsystem.cz/>.

9. Appendix A

The probe for measuring the moisture of compressed air should be placed directly on the pressure pipelines to achieve higher measurement accuracy and fast response times. But there are cases where such placement is not possible. The reason is the high air speed, high temperature, high pollution, small diameter pipes, etc. Such situation can be solved by placing the probe into the flow measuring chamber. The picture shows the basic layout of the sampling system with chamber SH-PP.

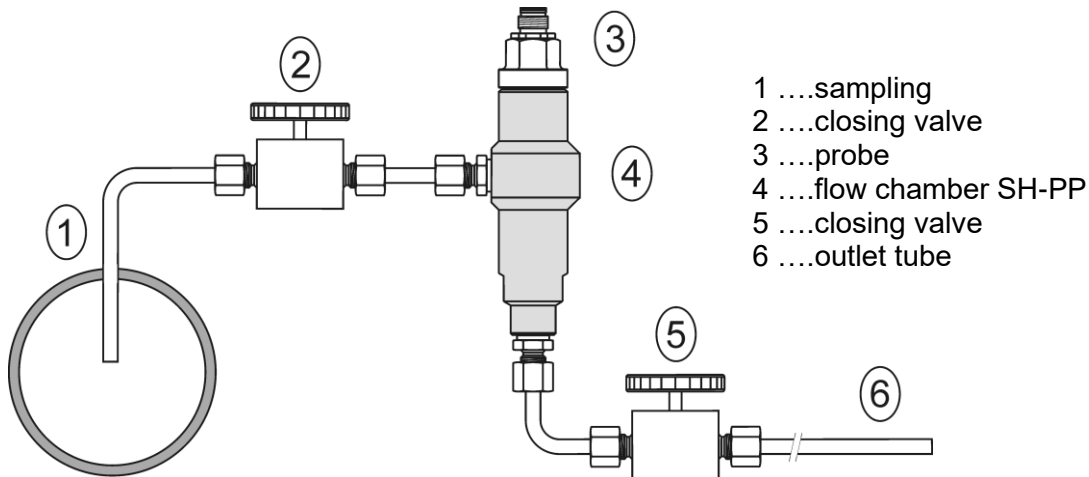

sampling (1) - end of the tube placed in the centre of pressure pipelines (distribution of moisture in the pipe cross-section is not homogeneous). To achieve fast response times to shorten the length of the sample tubes to a minimum (few meters).

closing valve (2) - allows access to the sample system without interrupting the main line

closing valve (5) - the sample flow is regulated by this valve. Measurement accuracy is typically not affected by the sample flow rate, but at low speeds, increasing response time.

outlet tube (6) - if the measured sample of air is released into the atmosphere, select the length of the outlet tube of 1.5 m (recommended for tube diameter 6mm). The reason is to ensure the accuracy of the sample in the flow chamber and avoid back diffusion of moisture from the ambient air.

That basic structure of sampling system can be supplemented with filters, coolers, flow measurement, pressure measurement, etc. For the accurate operation of sampling system is important to ensure perfect tightness of all connections and to use corrosion-resistant materials. Tube inclination is chosen so as to avoid the accumulation of fluid in the system.

Technical specification – flow chamber SH-PP

Material of flow chamber:	stainless steel (DIN 1.4301)
Inlet and outlet connection:	G1/8
Probe connection:	G1/2
Sample flow rate:	0.1 to 3 l/min
Operating pressure:	up to 25 bar
Weight:	580 g

Note: Screw-coupling not included

