



Temperature, humidity and pressure regulator

with RS232 serial output

H3331

H3331P

H4331

H7331

## **Instruction Manual**



## Table of content

<b>1. GENERAL DESCRIPTION</b> .....	<b>4</b>
<b>2. REGULATOR MOUNTING AND CONNECTION</b> .....	<b>4</b>
<b>3. DIMENSIONS</b> .....	<b>6</b>
<b>4. TYPICAL APPLICATION WIRING, CONNECTION OF TERMINALS</b> .....	<b>7</b>
<b>5. DESCRIPTION OF DEVICE FUNCTION AND SETTING</b> .....	<b>7</b>
5.1. DEVICE SETTING FROM THE MANUFACTURER .....	7
5.2. RELAY OUTPUTS .....	8
5.3. BINARY INPUTS .....	8
5.4. ACTUAL REGULATOR PRESET .....	8
5.4.1. Value assigned to output relay.....	9
5.4.2. When close output relay.....	9
5.5. REGULATOR SETTING CHANGE .....	10
5.5.1. Setting with PC and TSensor software.....	10
5.5.2. Setting with using regulator keys.....	10
5.5.3. Setting with using of Modbus communication protocol .....	11
5.6. EXTENDED SETTING MODE.....	11
5.7. RESTORE TO „FACTORY DEFAULT“ .....	16
<b>6. DESCRIPTION OF COMMUNICATION PROTOCOLS</b> .....	<b>16</b>
6.1. MODBUS RTU.....	17
6.1.1. Supported functions .....	17
6.1.2. Jumper .....	17
6.1.3. Modbus registers of the regulator.....	17
6.1.4. Far controlling of output relays status .....	18
6.1.5. Output relay alarm condition configuration with using of Modbus communication protocol <sup>2</sup> .....	19
6.2. PROTOCOL COMPATIBLE WITH ADVANTECH-ADAM STANDARD .....	20
6.2.1. Jumper .....	21
<b>7. ERROR STATES OF THE DEVICE</b> .....	<b>22</b>
<b>8. READINGS ON LCD DISPLAY</b> .....	<b>23</b>
<b>9. PREVENTIVE MAINTENANCE AND CALIBRATION</b> .....	<b>23</b>
<b>10. TECHNICAL SPECIFICATION</b> .....	<b>23</b>
10.1. TECHNICAL PARAMETERS.....	23
10.1.1. Common parameters.....	23
10.1.2. H3331(P) - temperature and humidity regulator.....	24
10.1.3. H4331 - temperature regulator, external probe.....	24
10.1.4. H7331 - temperature, relative humidity and pressure regulator .....	24
10.1.5. Value computed from measured relative humidity and temperature .....	25
10.1.6. Relative humidity and temperature restriction.....	26
10.2. OPERATING CONDITIONS .....	26
10.3. END OF OPERATION.....	27
10.4. TECHNICAL SUPPORT AND SERVICE.....	27
<b>11. APPENDIX A</b> .....	<b>28</b>
<b>12. APPENDIX B</b> .....	<b>28</b>
<b>13. APPENDIX C</b> .....	<b>29</b>
<b>14. APPENDIX D</b> .....	<b>30</b>

## General safety rules

The following summary is designed to prevent injury hazards or device damage. Operate the instrument in accordance with this manual to prevent electric trauma.

**Service should be performed by a qualified person only.**

**Connect and disconnect correctly.** Do not connect and disconnect a lead-in cables if the device is under electric voltage.

**Do not use the instrument without the cover.**

**Do not use the instrument, if it does not work correctly.** If the instrument seems not to work correctly, have it checked by a qualified service person.

**Do not use the instrument in an explosive environment.**

**Read instruction manual before the first device connection, please.**

**Before you remove probe of the regulator HxxxxP, make sure that the pressure in a pressure chamber (duct, pipe ... ) and the ambient pressure are in equilibrium.**

**Regulator version HxxxxP** is designed for compressed air measurement up to 25 bars.

**Models marked HxxxxZ** are non-standard versions of the devices. Description is not included in this manual.

**Copyright: COMET SYSTEM, s.r.o.** It is prohibited to copy and edit this instruction manual and make any changes at all without explicit agreement of COMET SYSTEM, s.r.o. All rights reserved.

COMET SYSTEM, s.r.o. makes constant development and improvement of all its products. Manufacturer reserves the right to make technical changes without previous notice. Misprints reserved.

Manufacturer is not responsible for damages caused by using the device in conflict with this manual. To damages caused by using the device in conflict with this manual cannot be provided free repairs during the warranty period.

Contact the manufacturer of this device:

COMET SYSTEM, s.r.o.  
Bezrucova 2901  
756 61 Roznov pod Radhostem  
Czech Republic  
[www.cometsystem.com](http://www.cometsystem.com)



**Authorized Distributor in Australia & New Zealand**  
**Pacific Sensor Technologies Pty Ltd**  
Unit 4, 3 Neutron Place Rowville, VIC 3178 Australia  
1300 662 720 | [sales@pacificsensortech.com.au](mailto:sales@pacificsensortech.com.au)  
[www.pacificsensortech.com.au](http://www.pacificsensortech.com.au)

# 1. General description

Regulators of Hx3xx line are designed for online monitoring of temperature in °C or °F, relative humidity of air without aggressive ingredients, barometric pressure and three binary inputs for detection of binary signals. Measured temperature and relative humidity are recomputed to following humidity expression: dew point temperature, absolute humidity, specific humidity, mixing ratio and specific enthalpy. It is possible to set correction for altitude (pressure offset) and to choose one of the following pressure units: hPa, kPa, mbar, mmHg, inHg, inH2O, PSI, oz/in2.

The device is equipped with two relay outputs for alarming or controlling of external devices. It is possible to assign any input value to each relay, to set comparing limit, delay, hysteresis, acoustic alarm or change its status by far control with using of Modbus communication protocol. The device communicates via link RS232.

Type	Temperature	Humidity	Pressure	Computed value	Binary inputs
<b>H3331</b>	✓	✓	-	✓	3x
<b>H3331P*/</b>	✓	✓	-	✓	3x
<b>H4331 **/</b>	✓	-	-	-	3x
<b>H7331</b>	✓	✓	✓	✓	3x

\*/ The removable probe for compressed air measurement is noninterchangeable part of the device.

The protection of connector is IP67

\*\*/ The type H4331 is designed for two wires connection of external Pt1000 temperature sensor.

Supported communication protocols are Modbus RTU and protocol compatible with standard Advantech-ADAM. Devices are preset from manufacturer to Modbus RTU communication protocol. If you would like to use different communication protocol then Modbus RTU, it is necessary preset them – see latter. Temperature, relative humidity and pressure sensors are non-removable instrument parts except H4431 device, that is designed for two wires connection of external Pt1000 temperature sensor. Measured and computed values are displayed on dual line LCD. It is also possible to display both readings with cyclic overwriting in 4 seconds interval. Display can be also switched OFF totally.

# 2. Regulator mounting and connection

Regulators are designed for wall mounting. Device must be mounted on the plane surface to prevent its deformation. Mounting holes and connection terminals are accessible after demounting of four screws in the corners of the box and removing the lid. There is recommended to use screws with half round head with cross-recessed screw ST 3.9 (DIN 7981).

Devices are supplied with cable (1,5 m) equipped with CANNON 9 connector for connection to RS232 interface.

Lace the lead-in cables (inputs, outputs, external temperature probe connectable to H4331) with outer diameter of 3 to 6.5 mm through the glands at the case wall and connect them according schematic below. Terminals are self-clamping and can be opened by a suitable screwdriver. For the opening, insert the screwdriver to smaller terminal hole and lever by him. Do not forget to tighten glands and case lid with inserted packing after cables connecting. **Insert attached plug into unused cable glands too.** Do NOT connect the regulator under voltage.

It is NOT recommended to use the device for long time under condensation conditions. It could be the cause of water steam condensation inside the sensor's cover into water phase. This liquid phase stays inside sensor's cover and can't escape from the cover easily. It can dramatically increase response time to relative humidity change. If water condensation occurs for longer time it can cause sensor damage. Similar effect can occur under water aerosol conditions.

External temperature probe connectable to H4331 must be type of "two wires with shielding". The probe cable length and size of conductor affects measurement accuracy. If connected probe is equipped with metal stem, we recommend using probes with metal stem not connected to cable shielding. Or else it is necessary to arrange metal stem is not connected to any other circuitry.

The cables for binary inputs and external sensor for regulator H4331 must be placed as far as possible from potential interference sources. The cables should not be led in parallel along power cabling. Safety distance is up to 0.5 m, otherwise undesirable induction of interference signals can appear. Maximum cable length is 10 m. Connect cable shielding to proper terminal and do not connect it to any other circuitry and do not ground it.

The device H3331P is designed to measure pressured air. It is good to mount probe directly into high pressure area (i.e. air pressured pipe) if it is possible. There is other possibility to use flow chamber SH-PP, see "Appendix B".

Electrical system (wiring) may do only worker with required qualification by rules in operation.

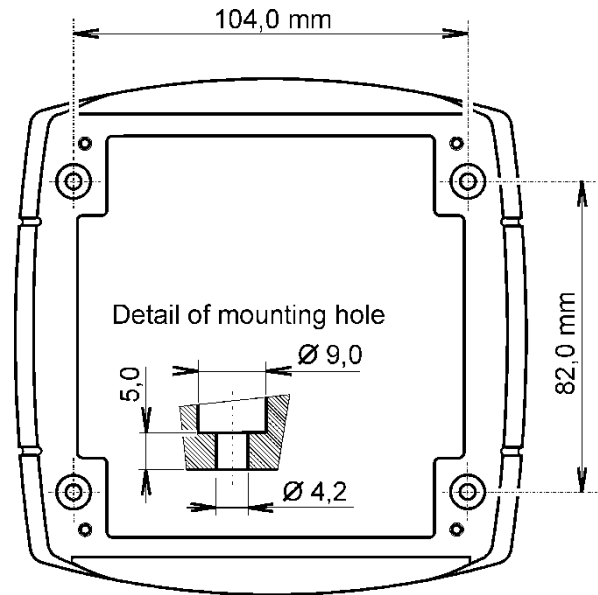

### 3. Dimensions

**H4331**

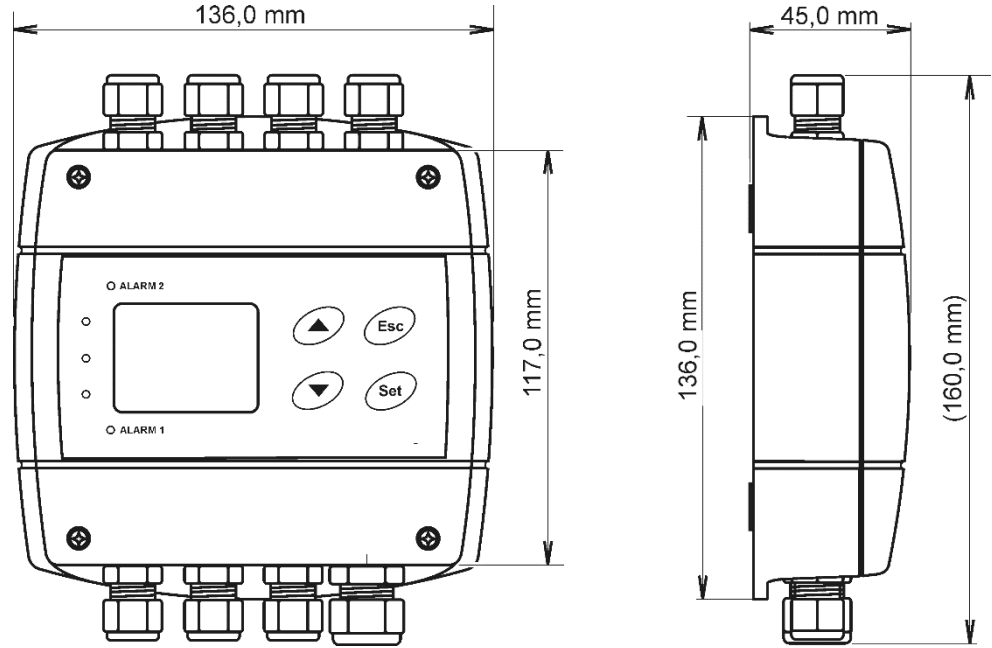

**H3331(P)  
H7331**

**Probe for compressed  
air measurement**

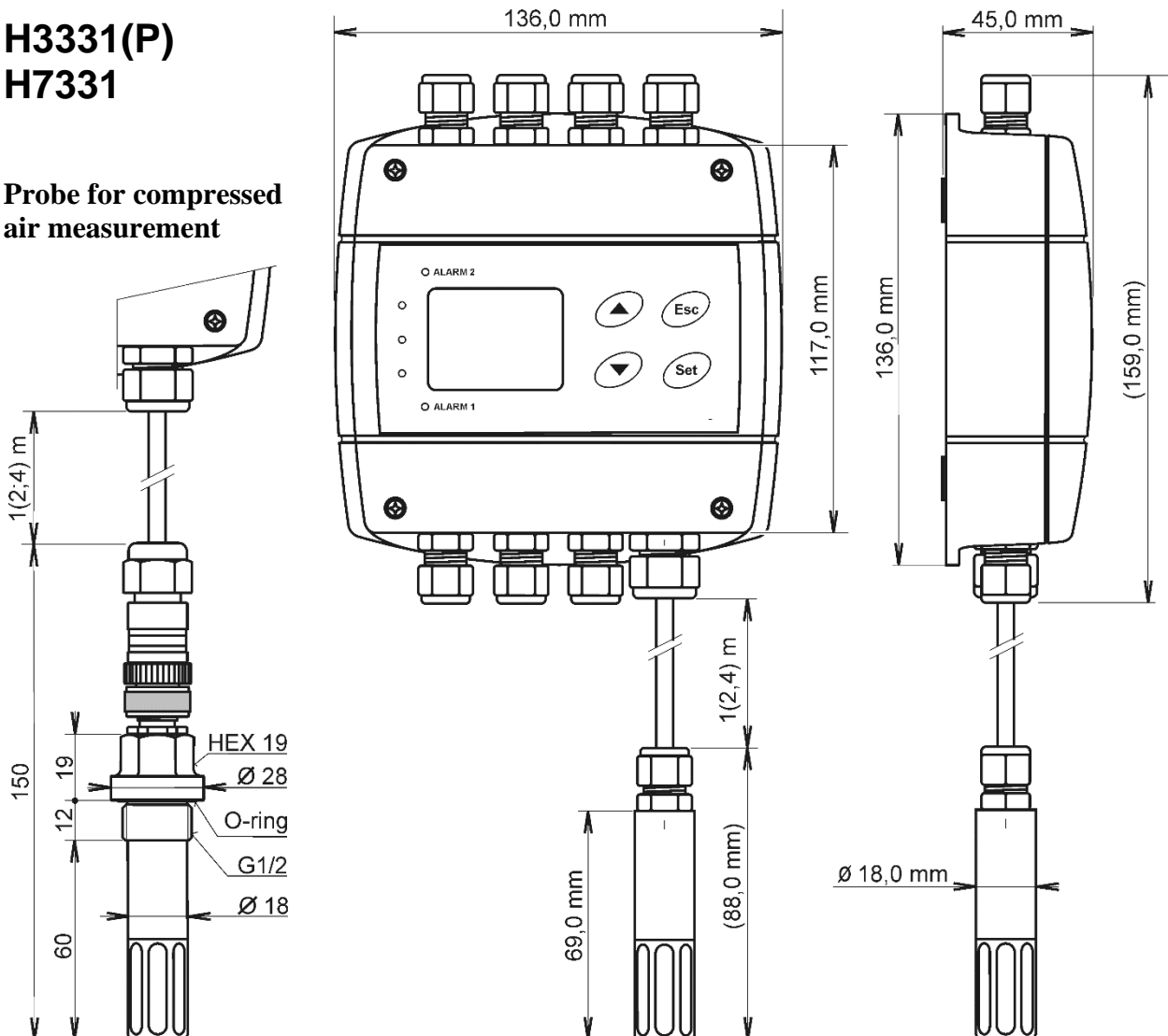

## 4. Typical application wiring, connection of terminals

DTR and RTS signals are specified for regulator supply. In case of insufficient performance of the PC communication port it is necessary to use an external power source.

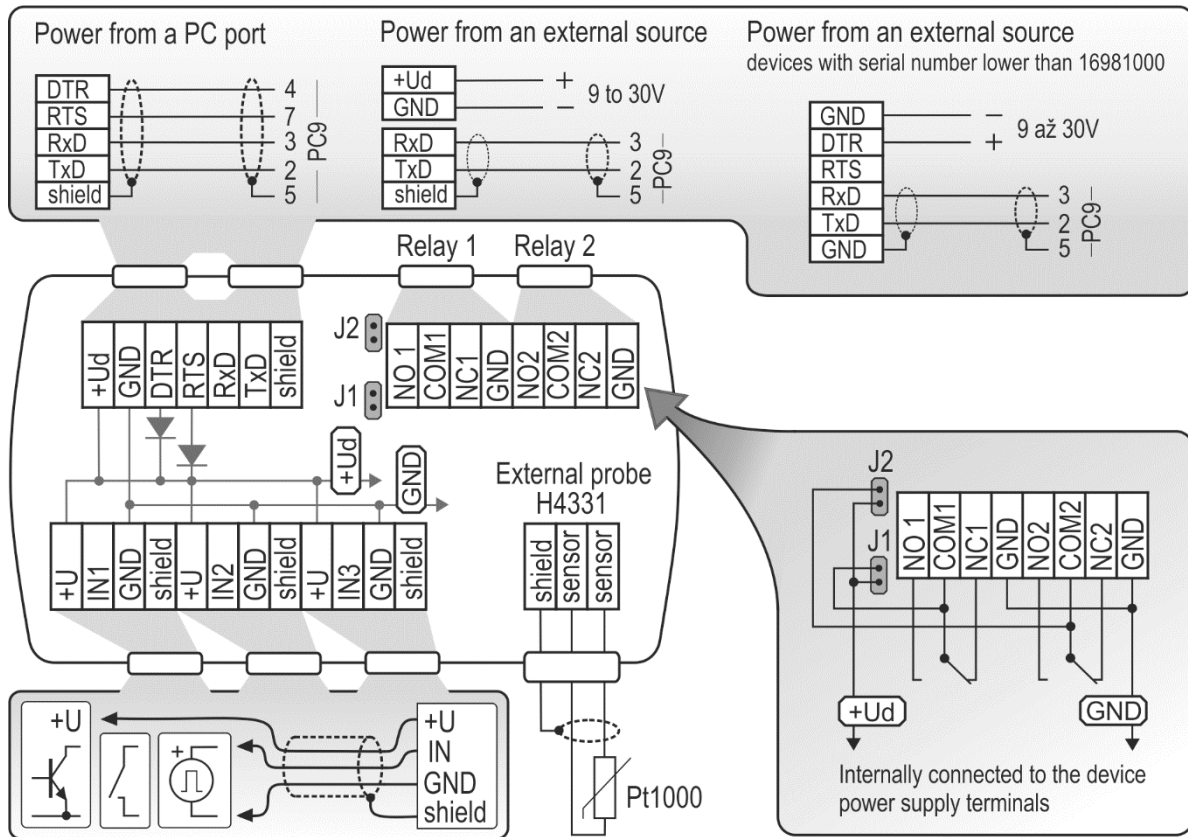

## 5. Description of device function and setting

Information from regulator is available directly through LCD or you can read them with one of next communication protocols ( Modbus RTU, Advantech-ADAM ).

### 5.1. Device setting from the manufacturer

communication protocol:	<b>Modbus RTU</b>
regulator address:	<b>1</b>
communication speed:	<b>9600Bd, no parity, 2 stop bits</b>
Value assigned to Relay1 and Relay2:	<b>none</b>
Password for setting through keys (PASS):	<b>0000</b>
LCD display:	<b>on</b>
value shown at first LCD line:	<b>temperature (temperature/pressure) – by device type</b>
value shown at second LCD line:	<b>relative humidity / dew point temperature</b>
temperature unit:	<b>°C</b>
pressure unit:	<b>hPa</b>
correction for altitude:	<b>0 hPa (absolute pressure)</b>
computed value preset:	<b>dew point temperature</b>
relay response for error:	<b>stay unchanged at previous condition</b>
signalization of binary inputs status:	<b>LED diode lights if input contact is open</b>
acoustic alarm:	<b>off</b>

## 5.2. Relay outputs

Regulator is equipped with two relay outputs. It is possible to assign any input or computed value or “Far condition” (see chapter 6.1.4 at page 18) to each relay, to set comparing alarm limit, if the relay may close if measured value is higher (Hi) or lower (Lo) than preset limit, delay for while must be preset condition true before relay close its contact and hysteresis for return to open status. For binary inputs: if it is preset to „HI“ then output relay is closed when input contact is opened, if it is preset to „Lo“ then output relay is closed when input contact is closed. Each relay status is indicated with LED diode and shown on LCD with corresponding symbols „ALARM 1“ or „ALARM 2“.

Terminal block for connecting the relays is equipped with terminals GND, which are connected to the power supply of the device (see chapter “*Typical application wiring, connection of terminals*”). When you need to use relays to switching the voltage identical with the supply voltage of the device, you can use jumpers J1 and J2 for interconnection the power supply of the device directly with the common contacts of the relays. **This modification is used in devices with serial number higher than 16981000** (the wiring diagram of the relay contacts for devices with serial number lower than 16981000 is given in the “*Appendix D*”).

The devices are equipped with two relays that are not intended for direct switching power circuits or mains voltage. If necessary, use suitable type of external relay (an example of wiring is given in the “*Appendix A*”).

## 5.3. Binary inputs

It is possible to read status of three galvanically not isolated binary inputs. It is possible to connect “open contact” or external voltage. Auxiliary power supply +U terminal can be used to supplying of external sensors and detectors. Visualization of binary inputs is done by three LED diodes placed on the left side from LCD. Green one represents input Binary 1, yellow input binary 2 and red input binary 3. If binary input is not connected or is without any signal, then binary input is interpreted as „1“, when input contact is closed (connected input), then binary input is interpreted as „0“. For each binary input there is possible to set indication LED function – if is lighting when binary input is closed or opened. Binary input status can be assigned to any of output relays. It is possible to choice if output relay is closed or opened when binary input is closed/opened.

## 5.4. Actual regulator preset

It is possible to display actual regulator preset on its LCD display by pressing of „▲“ key. If „Output relay alarm condition configuration with using of Modbus communication protocol“ is active (Remote Control), then device’s LCD display shows text „bloc“. It means, device’s keyboard is disabled for time of remote control (setting change), see chapter 6.1.5 at page 19. LCD shows information about Relay1 and then Relay2 setting step by step. Information about Relay1 are indicated with symbol „ALARM 1“, for Relay2 with symbol „ALARM 2“ (at right top corner of LCD). It is possible to edit parameters after pressing „SET“ key and entering of correct password „PASS“ – see chapter „*Change of “Password for setting through keys” (PASS)*” at page 12. Following examples are for Relay1 setting, similarly are displayed values for Relay2. Pressing of „ESC“ key ends this mode and switch to actual value displaying, the same occur if more than 20 s is not pressed any key.

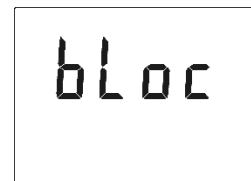



### 5.4.1. Value assigned to output relay

*None, relay is still off*

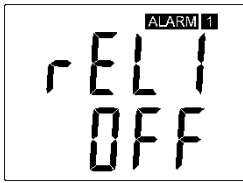

*Temperature at °C*



*Relative humidity*

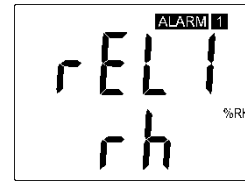

*Computed value  
(dew point temperature)*



*Barometric pressure*



*Binary input 1, input 2  
and 3 similarly*

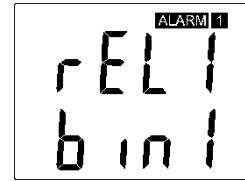

*far condition 0*



*far condition 1*



FAR0 – „far condition 0“: after device’s power on the relay is open

FAR1 – „far condition 1“: after device’s power on the relay is close

If “far condition” is assigned to output relay, then there is possible to change the output relay status by Modbus communication protocol only. See chapter 6.1.4 at page 18.

### 5.4.2. When close output relay

**High limit „HI“** – the relay closes when measured value exceeds preset „high limit” for longer time than preset „delay time“. Relay goes open when measured value decrease under „high limit“ value minus the „hysteresis” value. See example.

*High limit „HI“*



*Delay [s]*



*Hysteresis*

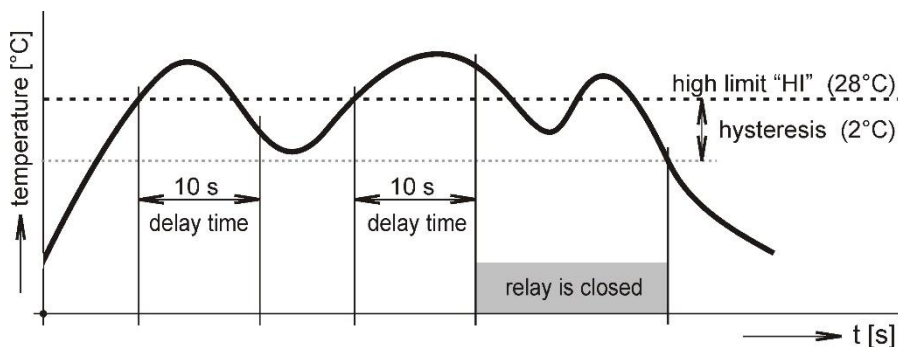

**Low limit „Lo“** – the relay closes when measured value falls below preset „low limit“ for longer time than preset „delay time“. Relay goes open when measured value exceeds „low limit“ value plus the „hysteresis“ value. See example.

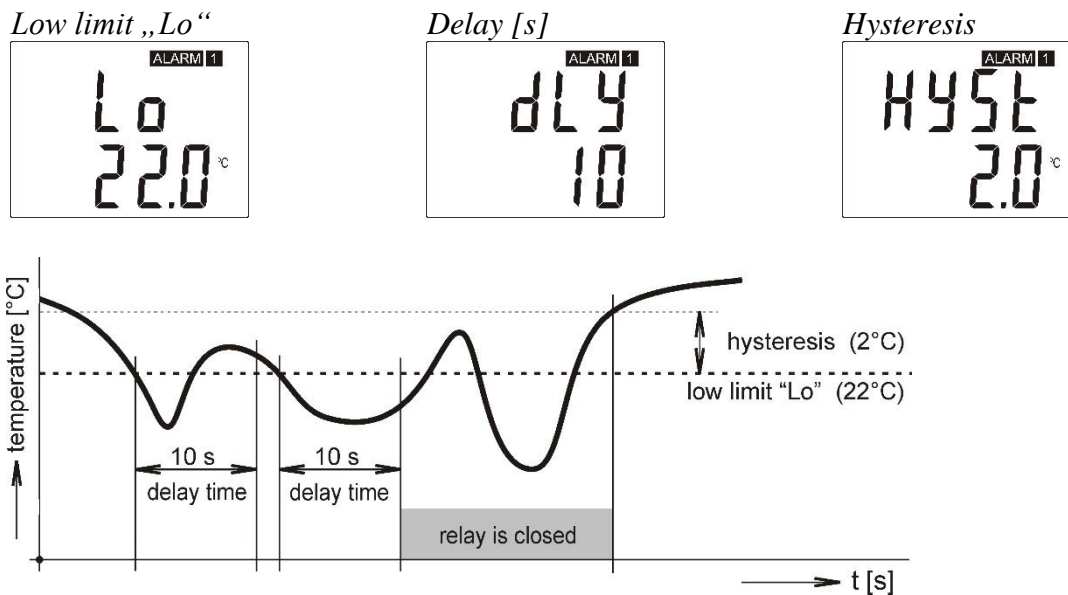

## 5.5. Regulator setting change

### 5.5.1. Setting with PC and TSensor software

User's software **TSensor** provides **setting of all regulator parameters**. The program is available free to download at web page [www.cometsystem.com](http://www.cometsystem.com). Run the TSensor program and follow the program instructions. Regulator includes hardware write protection of internal setting, new setting is possible to write only while:

1. during write period press „SET“ key – do requested setting in TSensor software, press „SET“ key on regulator and keep it down, then click on the button „Save Changes“ into TSensor software and after end of write release „SET“ key, or
2. jumper placed nearby keys is closed (jumper is accessible after demounting of four screws in the corners of the box and removing the lid ). This jumper is suitable e.g. until device adjustment is in process and regulator is placed into calibration box and keys are not accessible. Don't forget to remove (open) jumper after procedure finish (restore write protection)

TSensor software supports to make the adjustment of the regulator too. This procedure is described at file „*Calibration manual.pdf*“ which is installed commonly with the software.

### 5.5.2. Setting with using regulator keys

If „Actual regulator preset“ is displayed (see chapter „*Actual regulator preset*“ at page 8), it is possible to enter into edit mode and edit displayed value by pressing „SET“ key. Then you are asked for valid password (PASS). You can edit selected value if right password is entered. During value editing there is range check executed and edited value is still compared with limits for corresponding value (range). If inserted value is higher or lower then edited number is automatically changed to its maximum / minimum value – for possible range see chapter „*Technical parameters*“ at page 23. Value can be changed with using „▲“ and „▼“ keys. Edited value is switched in “round” -9, -8, -7, ...-2, -1, 0, 1, 2, ...8, 9. To edit next number digit press „SET“ key, for moving back to previous digit press

„ESC“ key. Edited value is stored by next „SET“ key pressing. It is possible to cancel editing by pressing „ESC“ key if necessary. If valid password is once inserted right, then there is possible to edit next items without asking for password insertion again, till “Actual regulator preset” is left (till actual measured values are shown). With new entering into edit mode it is necessary to enter Password again. Default password setting is preset from manufacturer to 0000, password change is possible into „Extended setting”. During edit mode regulator still works and changes are valid immediately after its storing – it is NOT necessary to restart regulator.

### 5.5.3. Setting with using of Modbus communication protocol

See chapter “Output relay alarm condition configuration with using of Modbus communication protocol”<sup>2</sup> at page 19.

## 5.6. Extended setting mode

During regulator operation it is possible to change parameters available through “Actual regulator preset” only (see chapter 5.4 at page 8). Rest of regulator parameters are available through “Extended setting mode”. **In this mode regulator does NOT communicate, does NOT do any measurements and does NOT service output relays. To leave this mode press „ESC“ key and open jumper nearby keys. To enter into Extended setting mode do following steps:**

1. disconnect power supply
2. demount four screws in the corners of the box and remove the lid
3. closed jumper placed nearby keys
4. press „▲“ and „▼“ keys together and keep them down
5. connect power supply to regulator – you should see message „SEL“ on the top line of LCD and on the bottom line you should see number of Firmware version (e.g. 0404)
6. release „▲“ and „▼“ keys – you are into “Extended setting mode” now

Use „▲“ and „▼“ keys to inspect each items. If you want to change some shown item then press „SET“ key, item starts blink. Now you can edit setting with using „▲“ and „▼“ keys. To store preset value press „SET“ key. Press „ESC“ key to leave editing (changing) without save – last stored value is kept.

### Acoustic alarm assign to Relay1

*acoustic indication of Relay1 is OFF*



*close of Relay1 contact starts acoustic indication*



**Acoustic alarm assign to Relay2**

*acoustic indication of Relay2 is OFF*

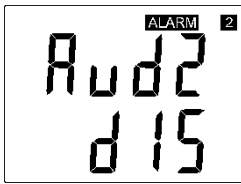

*close of Relay2 contact starts acoustic indication*



**Acoustic alarm deactivation**

*activated acoustic alarm is possible to deactivate by pressing „ESC“ key*

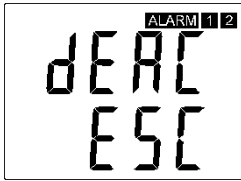

*acoustic alarm is still activated for all time and it is impossible to deactivate it*



**Relay response for error**

Regulator continuously checks its state during operation. In case error of assigned value measurement is found then output Relay1 (Relay2):

*stays unchanged  
(in previous status)*



*Relay1 switch OFF*



*Relay1 switch On*



*stays unchanged  
(in previous status)*



*Relay2 switch OFF*



*Relay2 switch On*



**Change of “Password for setting through keys” (PASS)**

This item shows actual password setting. It is possible to change it after „SET“ key pressing. It is number from range -19999 to +19999

*password setting*

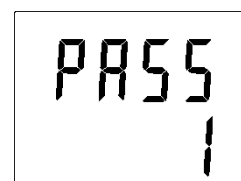

### Choice of communication protocol

Choice of communication protocol for communication with master device

*protocol Modbus*

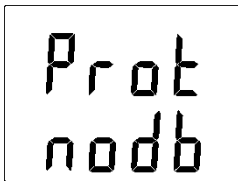

*protocol Advantech-Adam  
without check sum*

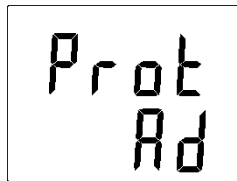

*protocol Advantech-Adam  
with check sum*



### Communication speed

Communication speed for preset communication protocol

*communication speed setting*

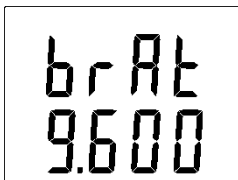

### Visualization of binary inputs

Visualization of inputs is done by three LED diodes. This option defines at which binary input status should LED diode indication lights – LED diode lights if binary input is OPEN or CLOSED.

*LED lights if binary input is OPEN*

*LED lights if binary input is CLOSED*

*Binary input 1,  
(similarly 2,3)*

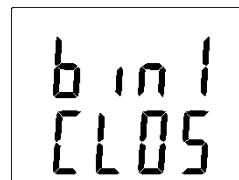
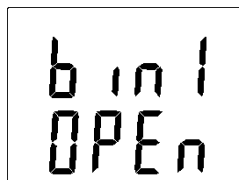

### Temperature unit choice

It is possible to measure temperature at °C or °F. There is shown preset unit. It is possible to change it after „SET“ key pressing.

*preset to °C*

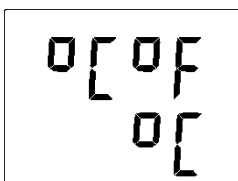

*preset to °F*

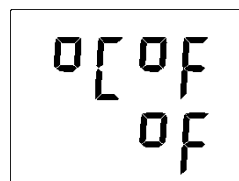

**Barometric pressure unit choice**

It is possible to measure barometric pressure at hPa, PSI, inHg, mBar, oz/in<sup>2</sup>, mmHg, inH<sub>2</sub>O and kPa. There is shown preset unit. It is possible to change it after „SET“ key pressing.

*preset to hPa*



*preset to PSI*

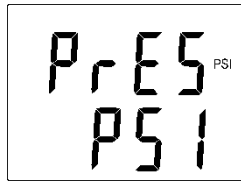

*preset to inHg*



*preset to mBar*



*preset to oz/in<sup>2</sup>*

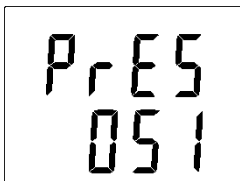

*preset to mmHg*



*preset to inH<sub>2</sub>O*



*preset to kPa*

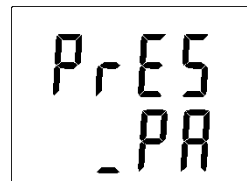

**Setting of pressure correction for altitude**

If it is necessary to read value of barometric pressure corrected with respect to altitude, it is possible to set corresponding pressure offset for this altitude. It is possible to change it after “SET” key pressing. Pressure correction value is then automatically added to measured pressure value. See chapter “Error States of the device” at page 22, Error 2.

*correction for altitude*

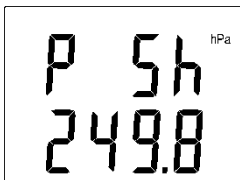

*pressure correction value is from*

-25,0 to 650,0 hPa  
 -0,363 to 9,427 PSI  
 -0,74 to 9,19 inHg  
 -25,0 to 650,0 mBar

-5,8 to 150,8 oz/in<sup>2</sup>  
 -18,8 to 487,5 mmHg  
 -10,0 to 261,0 inH<sub>2</sub>O  
 -2,5 to 65 kPa

**Show temperature at LCD display**

This item provides to choice if actual measured temperature may be displayed at LCD display or not. It is possible to change it after „SET“ key pressing.

*show value on LCD*

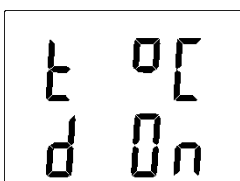

*don't show value on LCD*

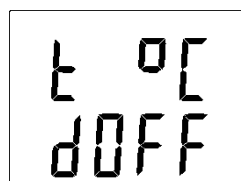

### Show relative humidity at LCD display

This item provides to choice if actual measured relative humidity may be displayed at LCD display or not. It is possible to change it after „SET“ key pressing.

*show value on LCD*

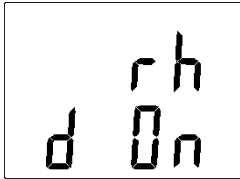

*don't show value on LCD*

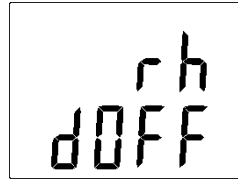

### Show computed value at LCD display

This item provides to choice if actual computed value may be displayed at LCD display or not. There is shown the name of computed value on the top LCD line – see “Computed value selection“ below. It is possible to change it after „SET“ key pressing.

*show value on LCD*

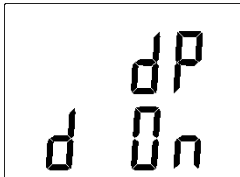

*don't show value on LCD*



### Show barometric pressure at LCD display

This item provides to choice if actual barometric pressure may be displayed at LCD display or not. It is possible to change it after „SET“ key pressing.

*show value on LCD*

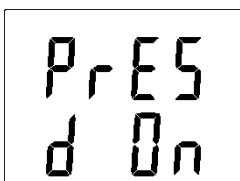

*don't show value on LCD*

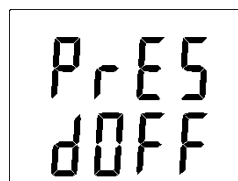

### Computed value selection

It shows the actually selected computed value name. It is possible to change it after „SET“ key pressing. There is possible choice one of the following computed values:

*dew point temperature   absolute humidity   mixing ratio   specific humidity*

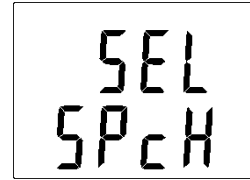
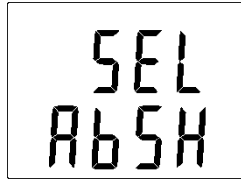

*specific enthalpy*

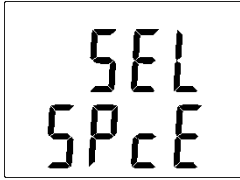

## 5.7. Restore to „Factory default“

This item provides regulator restoring to factory setting. Press „SET“ key, select „YES“ and confirm it by pressing of „SET“ key. It reset regulator parameters to following values:

communication protocol:	<b>Modbus RTU</b>
regulator address:	<b>1</b>
communication speed:	<b>9600Bd, no parity, 2 stop bits</b>
value assigned to Relay1 and Relay2:	<b>none</b>
password for setting through keys:	<b>0000</b>
display:	<b>on</b>
value shown at first LCD line:	<b>temperature (temperature/pressure), by device type</b>
value shown at second LCD line:	<b>relative humidity / dew point temperature</b>
temperature unit:	<b>°C</b>
pressure unit:	<b>hPa</b>
correction for altitude:	<b>0 hPa (absolute pressure)</b>
computed value preset:	<b>dew point temperature</b>

*restore to factory default*

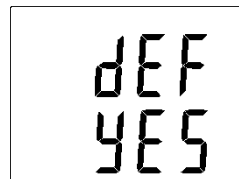
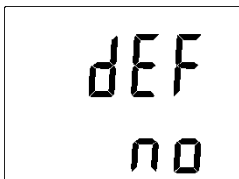

## 6. Description of communication protocols

Detailed description of each communication protocols including examples of communication is available into document “*Description of communication protocols*”, which is available to download at [www.cometsystem.cz](http://www.cometsystem.cz), see detailed description of appropriate device type.

After switching ON the power of the device it can last up to 3 s before the device starts to communicate and measure !!!



## 6.1. Modbus RTU

Control units communicate on master-slave principle in half-duplex operation. Only master can send request and only addressed device responds. During sending of request no other slave station should respond. During communication, data transfer proceeds in binary format. Each Byte is sent as eight bit data word in format: 1 start bit, data word 8 bit (LSB first), 2 stop bits<sup>1</sup>, without parity. Device supports communication speed from 110Bd to 115200Bd.

Sent request and response have syntax: ADDRESS OF DEVICE – FUNCTION – Modbus CRC

### 6.1.1. Supported functions

**03 (0x03):** Reading of 16-bit registers (Read Holding Registers)

**04 (0x04):** Reading of 16-bit input gates (Read Input Registers)

**06 (0x06):** Setting of one 16-bit register (Write Register)

**16 (0x10):** Setting of more 16-bit registers (Write Multiple Registers)

### 6.1.2. Jumper

Jumper (placed nearby keys) is accessible after demounting of four screws in the corners of the box and removing the lid. If communication protocol Modbus is selected the function of jumper is as follows:

- Jumper opened – device memory is protected from writing, from device side it is only enabled to read measured value, writing to memory is disabled (no change of settings is enabled)
- Jumper closed – writing to regulator memory is enabled

### 6.1.3. Modbus registers of the regulator

Variable	Unit	Address [hex] <sup>x</sup>	Address [dec] <sup>x</sup>	Format	Size	Status
measured temperature	[°C/°F]*	0x0031	49	Int*10	BIN16	R
measured relative humidity	[%]	0x0032	50	Int*10	BIN16	R
computed value*		0x0033	51	Int*10	BIN16	R
Relay1 status [0/1] (Alarm 1)	[-]	0x003B	59	Int	BIN16	R
Relay2 status [0/1] (Alarm 2)	[-]	0x003C	60	Int	BIN16	R
binary input 1 status [0/1]	[-]	0x003D	61	Int	BIN16	R
binary input 2 status [0/1]	[-]	0x003E	62	Int	BIN16	R
binary input 3 status [0/1]	[-]	0x003F	63	Int	BIN16	R
status of all binary inputs (bit0, 1, 2)	[-]	0x0008	8	Int	BIN16	R
status word (described below)	[-]	0x0007	7	Int	BIN16	R
device serial number Hi	[-]	0x1035	4149	BCD	BIN16	R
device serial number Lo	[-]	0x1036	4150	BCD	BIN16	R
firmware version Hi	[-]	0x3001	12289	BCD	BIN16	R
firmware version Lo	[-]	0x3002	12290	BCD	BIN16	R
device address	[-]	0x2001	8193	Int	BIN16	R/W**
communication speed code	[-]	0x2002	8194	Int	BIN16	R/W**

<sup>1</sup> Device sends two stop bits, for receive one stop bit is enough.

**Addition for H7331 regulators with barometric pressure measurement:**

Variable	Unit	Address [hex] <sup>x</sup>	Address [dec] <sup>x</sup>	Format	Size	Status
barometric pressure	hPa	0x0034	52	Int*10	BIN16	R
	PSI			Int*1000		
	inHg			Int*100		
	mBar			Int*10		
	oz/in <sup>2</sup>			Int*10		
	mmHg			Int*10		
	inH <sub>2</sub> O			Int*10		
	kPa			Int*100		

**Legend:**

- \* depends on device setting (by User's software)
- Int\*10 register is in format integer \*10 (likewise \*100, \*1000)
- R register is designed only for reading
- W\*\* register is designed for writing, but direct write is not available, for details see description of communication protocols
- x at transmit are register addresses indexed from zero - „zero based addressing“. For example „measured temperature“ with Modbus address 0x31 is physically sent along data bus as value 0x30. You make sure of correct addressing with the aid of Master device documentation or experimentally (e.g. for „measured temperature“ try to use address 0x31 or 0x30).
- Status word: 16b value return, bite description:
 

Bit0	0/1	jumper open/closed
Bit1	-	unused
Bit2	0	always 0
Bit3	0/1	Relay1 open/closed
Bit4	0/1	Relay2 open/closed
Bit5	0/1	internal acoustic alarm status
Bit6	0/1	binary input 1 status
Bit7	0/1	binary input 1 status
Bit8	0/1	binary input 1 status
Bit9 to 15	-	unused

**Note:** In case there is a need for reading of measured values from the device with higher resolution than one decimal, measured values in device are stored also in „Float“ format, which is not directly compatible with IEEE754.

**6.1.4. Far controlling of output relays status <sup>2</sup>**

There is possible to control output relay status (open/close) with using of Modbus communication protocol. To this function enable, there is necessary to assign one of following options to relay:

- FAR0 – „Far condition 0“, it means, after power up output relay will be open, or
- FAR1 – „Far condition 1“, it means, after power up output relay will be close.

<sup>2</sup> This function is available from firmware version 04.06. If older firmware used, update your firmware or contact device's distributor.

Then there is possible to change relay status by Modbus communication protocol command by requested value writing to following addresses:

Function	Address [hex] <sup>X</sup>	Address [dec] <sup>X</sup>	Description	Status
Far condition for Relay1	0x0042	66	0 ... Relay1 open 1 ... Relay1 closed	R/W
Far condition for Relay2	0x0043	67	0 ... Relay2 open 1 ... Relay2 closed	R/W

### 6.1.5. Output relay alarm condition configuration with using of Modbus communication protocol <sup>2</sup>

With Modbus communication protocol there is possible to set regulator's parameters described at chapter 5.4 at page 8. Follow next steps:

- 1) To address 0x0044 (68) write value 1 – it enables Modbus setting. By the way it blocks regulator's keyboard – local keyboard is blocked during remote control setting change.
- 2) Write the desired settings / changes to the addresses from 0x0045 (69) to 0x004E (78). New setting can be done simultaneously or each register can be written alone
- 3) To address 0x004F (79) write value 1. Once this step is done, new setting is physically stored into device memory (confirm change). Then registers 0x004F (79) and 0x0044 (68) are automatically cleared (zero). It automatically unlocks the keyboard too.  
Whole setting process can be cancelled by writing value 0 to address 0x0044 (68). At this time no changes are stored and last setting stays valid.

Function	Unit	Address [hex] <sup>X</sup>	Address [dec] <sup>X</sup>	Description	Status
Modbus Remote Control	[-]	0x0044	68	0 ... disable 1 ... enable (for this time device's keyboard is blocked, if key is pressed, message BLOC is shown)	R/W
Value assigned to output Relay1	by value	0x0045	69	0 ... Off 1 ... temperature 2 ... relative humidity 3 ... atmospheric pressure 4 ... computed value 5 ... binary input 1 6 ... binary input 2 7 ... binary input 3 8 ... Far condition 0 9 ... Far condition 1	R/W
When close Relay1	[-]	0x0046	70	0 ... alarm occurs, when measured value is LOWER than preset alarm value 1 ... alarm occurs, when measured value is HIGHER than preset alarm value	R/W

Function	Unit	Address [hex] <sup>X</sup>	Address [dec] <sup>X</sup>	Description	Status
Alarm value for Relay1	by value	0x0047	71	preset alarm value (threshold)	R/W
Delay for Relay1	[sec]	0x0048	72	Time in seconds Time in seconds that the condition must be valid to evaluate alarm	R/W
Hysteresis of Relay1	by value	0x0049	73	Value witch must be set back below / above a given threshold in order to open the relay	R/W
Value assigned to output Relay2	by value	0x004A	74	0 ... Off 1 ... temperature 2 ... relative humidity 3 ... atmospheric pressure 4 ... computed value 5 ... binary input 1 6 ... binary input 2 7 ... binary input 3 8 ... Far condition 0 9 ... Far condition 1	R/W
When close Relay2	[-]	0x004B	75	0 ... alarm occurs, when measured value is LOWER than preset alarm value 1 ... alarm occurs, when measured value is HIGHER than preset alarm value	R/W
Alarm value for Relay2	by value	0x004C	76	preset alarm value (threshold)	R/W
Delay for Relay2	[sec]	0x004D	77	Time in seconds Time in seconds that the condition must be valid to evaluate alarm	R/W
Hysteresis of Relay2	by value	0x004E	78	Value which must be set back below / above a given threshold in order to open the relay	R/W
Confirm changes	[-]	0x004F	79	Read always as 0 write 1 ... physically stores new setup into device's memory, at the end the register is automatically reset to zero.	R/W

All registers contains 16b number. Communication examples are listed in a separate document entitled "Description of communication protocols“.

## 6.2. Protocol compatible with Advantech-ADAM standard

Control units communicate on master-slave principle in half-duplex operation. Only master can send requests and only addressed device responds. During sending request any of slave devices should respond. During communication data is transferred in ASCII format (in characters). Each Byte is sent as two ASCII characters. Device supports communication speed from 1200Bd to 115200Bd, parameters of communication link are 1 start bit + eight bit data word (LSB first) + 1 stop bit, without parity.

### 6.2.1. Jumper

Jumper (placed nearby keys) is accessible after demounting of four screws in the corners of the box and removing the lid. If communication protocol compatible with standard Advantech-ADAM is selected, its function is the following:

- If jumper during switching ON the power is closed, device always communicates with following parameters regardless stored setting in the device:  
communication speed 9600 Bd, without check sum, device address 00h
- If jumper during switching ON the power is not closed, device communicates in accordance with stored setting.
- If jumper is closed during device operation, device temporarily changes its address to 00h, it will communicate in the same communication speed as before closing jumper and will communicate without check sum. After jumper is opened setting of address and check sum is reset in accordance with values stored in the device.
- Communication speed and check sum are possible to change only if jumper is closed.
- Jumper closed and button pressed for longer than six seconds – causes restoring of manufacturer setting **of communication protocol**, i.e. sets Modbus RTU communication protocol, device address sets to 01h and communication speed to 9600Bd (after button press there is “dEF” message blinking at LCD display. Six seconds later message “dEF” stays shown, it means manufacturer setting **of communication protocol** is done).

For communication with device which measure more than one value, there is necessary to add at the end of command, number of communication channel, where the measured value is mapped. Command for value reading is **#AAx(CRC) CR**, where **AA** is device address and **x** is number of communication channel by next table:

Measured value	Number of communication channel
temperature	0
relative humidity	1
computed value	2
barometric pressure	3
status word (described below)*	4
Relay1 status [0/1]	5
Relay2 status [0/1]	6
binary input 1 status [0/1]	7
binary input 2 status [0/1]	8
binary input 3 status [0/1]	9

\* Status word: 16b value return, bite description:

Bit0	0/1	jumper open/closed
Bit1	-	unused
Bit2	0	always 0
Bit3	0/1	Relay1 open/closed
Bit4	0/1	Relay2 open/closed
Bit5	0/1	internal acoustic alarm status
Bit6	0/1	binary input 1 status
Bit7	0/1	binary input 1 status
Bit8	0/1	binary input 1 status
Bit9 to 15		unused

## 7. Error States of the device

Device continuously checks its state during operation. In case error is found LCD displays corresponding error code:

**Error 0** - first line of LCD displays „Err0“. Check sum error of stored setting inside device's memory. This error appears if incorrect writing procedure to device's memory occurred or if damage of calibration data appeared. At this state device does not measure and calculate values. It is a serious error, contact distributor of the device to fix.

**Error 1** - measured or calculated value except in pressure is over upper limit of allowed full scale range. There is a reading „Err1“ on LCD display. Value read from the device is +999.9. This state appears in case of:

- Measured temperature is higher than approximately 600°C (i.e. high non-measurable resistance of temperature sensor, probably opened circuit).
- Relative humidity is higher than 100%, i.e. damaged humidity sensor, or humidity calculation of humidity is not possible (due to error during temperature measurement).
- Computed value – calculation of the value is not possible (error during measurement of temperature or relative humidity or value is over range).

The value of pressure +999.9 hPa is correct value!

**Error 2** - there is a reading „Err2“ on LCD display. Measured or calculated value is below lower limit of allowed full scale range. Value read from the device is -999.9. This state appears in case of:

- Measured temperature is lower than approximately -210°C (i.e. low resistance of temperature sensor, probably short circuit).
- Relative humidity is lower than 0%, i.e. damaged sensor for measurement of relative humidity, or calculation of humidity is not possible (due to error during temperature measurement).
- Measured pressure value **with added correction for altitude** is outside of range from 300 hPa to 1350 hPa (from 4.351 PSI to 19.580 PSI) or the pressure sensor is damaged. Please check setting of pressure correction for altitude with User's software.
- Computed value – calculation of computed value is not possible (error during measurement of temperature or relative humidity)

**Error 3** - there is a reading „Err3“ on LCD display upper line. Error of internal A/D converter appeared (converter does not respond, probably damage of A/D converter). This error does NOT affect pressure measurement. Rest values are NOT measured. It is a serious error, contact distributor of the device.

**Error 4** - there is a reading „Err4“ on LCD display. It is internal device error during pressure sensor initialization. Under this condition device does NOT measure atmospheric pressure. Value read from device is -999.9. Pressure sensor is probably damaged. It is a serious error, contact distributor of the device.

**Error 5, 6** - there is problem with assigned value to output relay, there is some wrong setting (mismatch). This error appears if incorrect writing procedure to device's memory occurred.

**Error 9** - inserted password is not valid, there is shown for short time message “Err9” on LCD display.

## 8. Readings on LCD display

°C, °F reading next to this symbol is measured temperature or error state of value

%RH reading next to this symbol is measured relative humidity or error state of value

**hPa, PSI, inHg** reading next to this symbol is measured pressure or error state of value. If selected pressure unit is **mBar** or **oz/in<sup>2</sup>** or **mmHg** or **inH<sub>2</sub>O** or **kPa**, there is shown only value (number) without corresponding pressure unit!

°C / °F **DP** reading next to this symbol is calculated dew point temperature or error state of value

**g/m<sup>3</sup>** reading next to this symbol is calculated absolute humidity or error state of value

**g/kg** reading next to this symbol is calculated specific humidity or mixing ratio (depends on device setting) or error state of value

**3** this symbol is on if jumper is closed

If specific enthalpy is selected, there is shown only value (number) without corresponding unit.

## 9. Preventive maintenance and calibration

Pay heed to recommended calibration interval. Do not subject the device to mechanical stress.

## 10. Technical specification

### 10.1. Technical parameters

#### 10.1.1. Common parameters

**Power voltage:** 9 to 30 V DC

**Power consumption:** approx. 1 W + consumption of sensors and detectors connected to +U terminals

**Measuring interval:** temperature, relative humidity . . . . . 0,5s  
barometric pressure . . . . . 2s

**Display switching interval:** 4 s (when more than two values are displayed)

**Relay outputs:**

Amount: 2

Maximal voltage: 50 V

Maximal current: 2A

Maximal power: 60 VA

Relays contact is not designed for direct control of line voltage!

(output relay contact parameters: max 220Vdc, 125Vac, 2A, 60 W, 62.5 VA)

**Binary inputs:**

Amount: 3

Signal for binary input: from floating contact or binary voltage

Caution! Binary inputs are NOT galvanic isolated!

Minimal input pulse duration: 500 ms (detection of shorter pulses is not guaranteed)

Current through closed contact: 25  $\mu$ A

Open contact voltage: < 3,3 V

Maximal input voltage: +30 V

Low level input voltage: 0 to +0,5 V

Hi level input voltage: +3,0 to +30 V

Auxiliary power supply +U: 9 to 30 V DC (depends on voltage connected to DTR and/or RTS minus about 1V), overall current max. 100 mA

Cable for input signal wiring: shielded, max. 10 m long, cable should not be led in parallel along power cabling.

EMC: EN 61326-1, EN 55011

### 10.1.2. H3331(P) - temperature and humidity regulator

#### Temperature:

Accuracy:  $\pm 0,4$  °C ( $\pm 0,7$  °F)

Range: -30 to +105 °C (-22 to 221 °F), includes probe cable

Resolution: 0,1 °C (0,2 °F)

#### Relative humidity:

Accuracy:  $\pm 2,5$  %RH from 5 to 95 %RH at 23 °C (73,4 °F)

Range: 0 to 100 %RH

Resolution: 0,1 %RH

**Measuring temperature and humidity range is limited in accordance with the graph below!**

**Response time** with stainless steel mesh sensor cover (F5200B) and bronze sensor cover (F0000 - selectable option), air flow approximately 1 m/s:

temperature: H3331, H7331  $t_{90} < 6$  min (temperature step 20 °C (36 °F))

H3331P  $t_{90} < 16$  min (temperature step 20 °C (36 °F))

relative humidity:  $t_{90} < 30$  s (humidity step 65 %RH, constant temperature)

### 10.1.3. H4331 - temperature regulator, external probe

designed for two wires connection of external Pt1000 temperature sensor

Probe: Pt1000/3850 ppm connected by shielded cable of maximum length 10m

Range: -200 to +600 °C (-328 °F to 998.6 °F) Resolution: 0,1 °C (0,2 °F)

Accuracy:  $\pm 0,2$  °C ( $\pm 0,4$  °F) without probe

### 10.1.4. H7331 - temperature, relative humidity and pressure regulator

Technical parameters are the same as regulator H3331, plus barometric pressure.

Unit	hPa, mBar	PSI	mmHg	inHg	inH <sub>2</sub> O	oz/in <sup>2</sup>	kPa
Range	600	8.70	450.0	17.72	240.9	139.2	60.00
	1100	15.95	825.1	32.48	441.6	255.3	110.00
accuracy							
T=23 °C ( T=73,4°F )	$\pm 1.3$	$\pm 0.02$	$\pm 1.0$	$\pm 0.04$	$\pm 0.5$	$\pm 0.3$	$\pm 0.13$
0≤T≤40°C ( 32≤T≤104°F )	$\pm 1.5$	$\pm 0.02$	$\pm 1.1$	$\pm 0.04$	$\pm 0.6$	$\pm 0.3$	$\pm 0.15$
Else	$\pm 2.0$	$\pm 0.03$	$\pm 1.5$	$\pm 0.06$	$\pm 0.8$	$\pm 0.5$	$\pm 0.20$

**Response time**<sup>3</sup>: pressure  $t_{90} < 44$ s

<sup>3</sup> There is possible to change response time. For more details see file "Description of calibration and adjustment procedure.pdf", which is installed together with Users software.



### 10.1.5. Value computed from measured relative humidity and temperature

You can choice one of the following value:

#### Dew point temperature

Range: -60 to +80 °C (-76 to 176 °F)

Accuracy:  $\pm 1,5^{\circ}\text{C}$  ( $\pm 2,7^{\circ}\text{F}$ ) at ambient temperature  $T < 25^{\circ}\text{C}$  ( $77^{\circ}\text{F}$ ) and relative humidity  $\text{RH} > 30\%$ , for more details see graphs below

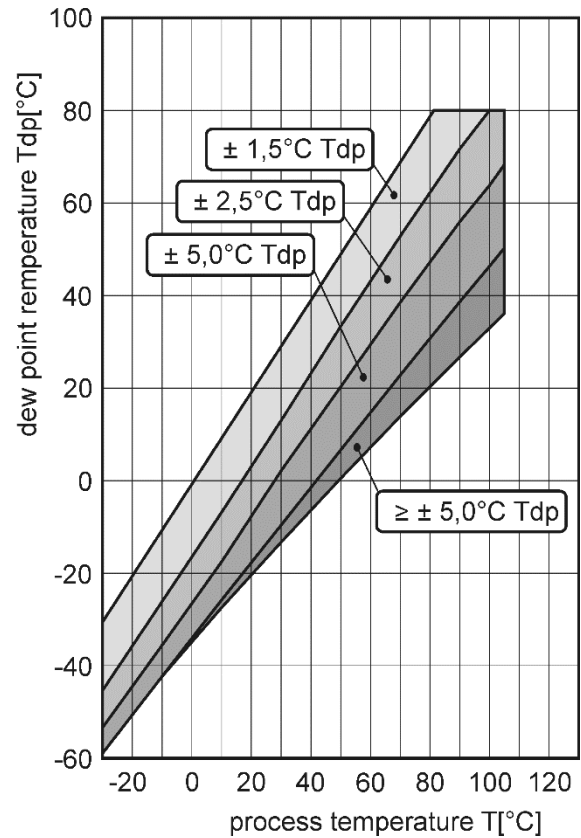
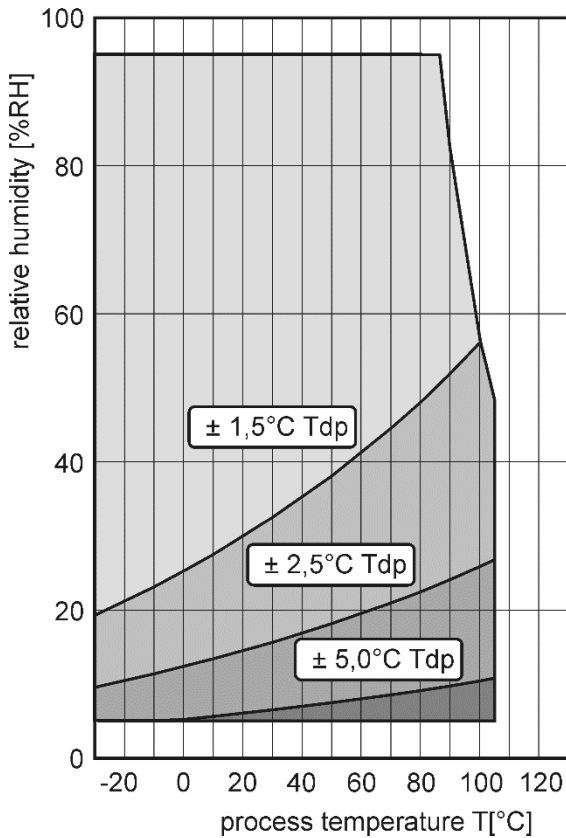

#### Absolute humidity

Range: 0 to 400 g/m<sup>3</sup>

Accuracy:  $\pm 1,5$  g/m<sup>3</sup> at ambient temperature  $T < 25^{\circ}\text{C}$  ( $104^{\circ}\text{F}$ ), for more details see graph below

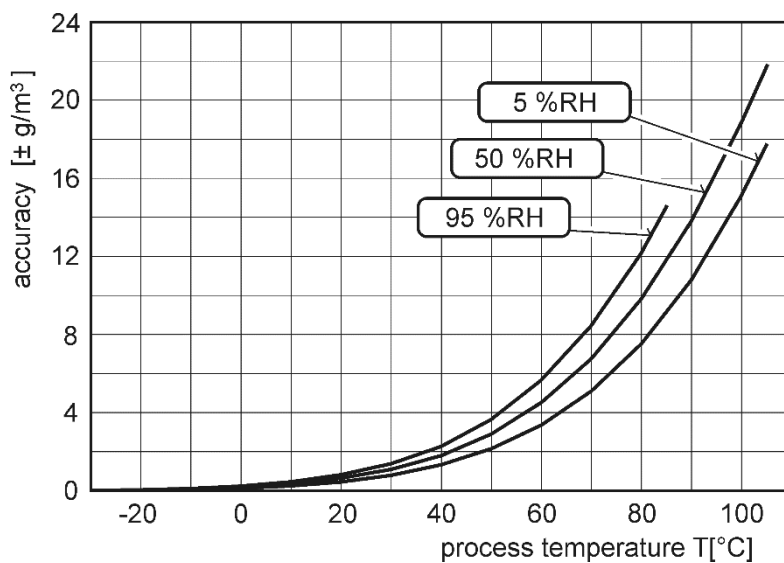

### Specific humidity<sup>4</sup>

Accuracy:  $\pm 2$ g/kg at ambient temperature  $T < 35^{\circ}\text{C}$  ( $95^{\circ}\text{F}$ )

Range: 0 to 550 g/kg

### Mixing ratio<sup>4</sup>

Accuracy:  $\pm 2$ g/kg at ambient temperature  $T < 35^{\circ}\text{C}$  ( $95^{\circ}\text{F}$ )

Range: 0 to 995 g/kg

### Specific enthalpy<sup>4</sup>

Accuracy:  $\pm 3$ kJ/kg at ambient temperature  $T < 25^{\circ}\text{C}$  ( $77^{\circ}\text{F}$ )

Range: 0 to 995 kJ/kg<sup>5</sup>

The values computed from ambient temperature and relative humidity including their accuracy you can exactly determine by the program **Conversions**. It is free to download at [www.cometsystem.com](http://www.cometsystem.com).

## 10.1.6. Relative humidity and temperature restriction

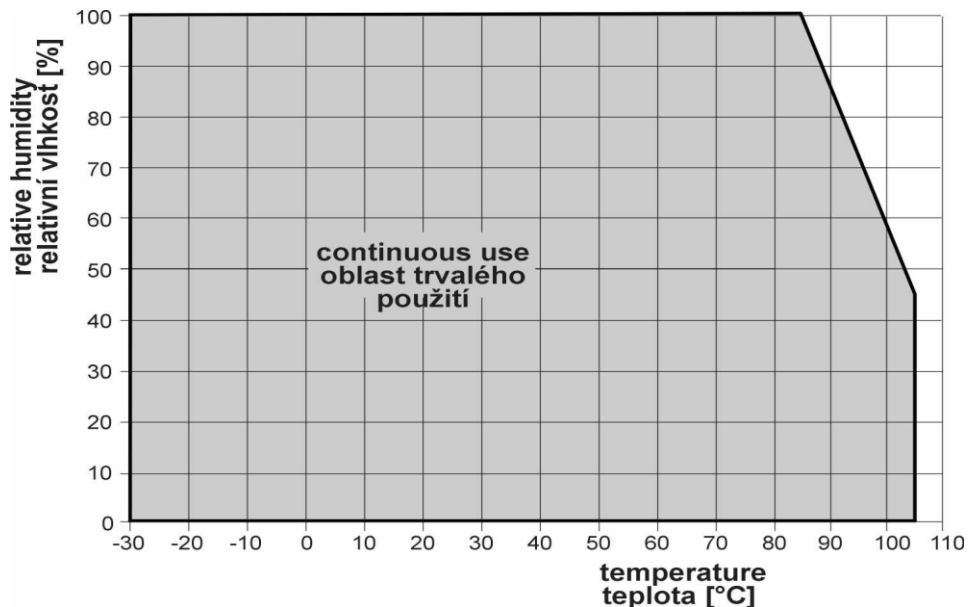

## 10.2. Operating conditions

### Operating temperature and relative humidity:

**electronics:**  $-30$  to  $+80^{\circ}\text{C}$  ( $-22$  to  $176^{\circ}\text{F}$ ), 0 to 100 % RH (without condensation)

**probe H3331(P), H7331:**  $-30$  to  $+105^{\circ}\text{C}$  ( $-22$  to  $221^{\circ}\text{F}$ ) probe cable included,  
0 to 100 %RH

**external probe for H4331:** by probe type (not included)

*It is recommended to switch off the LCD display at ambient temperatures above  $70^{\circ}\text{C}$  ( $158^{\circ}\text{F}$ ) – around electronics.*

<sup>4</sup> This value depends on the atmospheric pressure. For computing is used constant value stored in device memory. Default value preset by manufacturer is 1013hPa and can be changed by user's software.

<sup>5</sup> This maximum is reached under conditions about  $70^{\circ}\text{C}/100\%RH$  or  $80^{\circ}\text{C}/70\%RH$

**Operating pressure range of probe H3331P:** up to 25 bar

**Air flow velocity (H3331P probe):** up to 25 m/s at a pressure of 1bar (1m/s at a pressure of 25 bar)

**Protection:**

**H3331(P).** . . . case with electronics IP65 (sensors are located in cover with IP40 protection )

**H4331** . . . . . IP65

**H7331** . . . . . case with electronics IP54 (sensors are located in cover with IP40 protection )

**Other environmental conditions (external influences) according to HD 60364-5-51:** normal

**Recommended calibration interval:**

**H331(P)** 1 year

**H4331** 2 years

**H7331** 1 year

**Working position:** negligible

**Not allowed manipulations:** It is not allowed to operate the device under conditions other than specified in technical parameters. Devices are not designed for locations with chemically aggressive environment. Temperature and humidity sensors must not be exposed to direct contact with water or other liquids. It is not allowed to remove the sensor cover to avoid any mechanical damage of the sensors.

**Storage conditions:** -30 to +80 °C (-22 to 176 °F), 0 to 100 % RH (without condensation)

**Mechanical connection of probe H3331P:** G1/2 with O-ring

**Dimensions:**see dimensional drawings

**Weight:** approximately:

H4331 430 g

H3331/1m probe, H7331/1m probe 500 g

H3331/2m probe, H7331/2m probe 540 g

H3331/4m probe, H7331/4m probe 620 g

H3331P/1m probe 550g, H3331P/2m probe 590g, H3331P/4m probe 670g

**Material of the case:** ASA

**Material of the probe H3331P:** duralumin with the black eloxal surface finish

### 10.3. End of operation

Device itself (after its life) is necessary to liquidate ecologically!

### 10.4. Technical support and service

The adjustment procedure is described at file „*Calibration manual.pdf*“ which is installed commonly with the TSensor software.

Technical support and service is provided by distributor. For contact see warranty certificate. You can use discussion forum at web address: <http://www.forum.cometsystem.cz/>.

## 11. Appendix A

### Connection of external power relay

#### Coil data chart of external power relay:

nominal voltage : max 50V  
 nominal power: max 60VA  
 current: max 2A

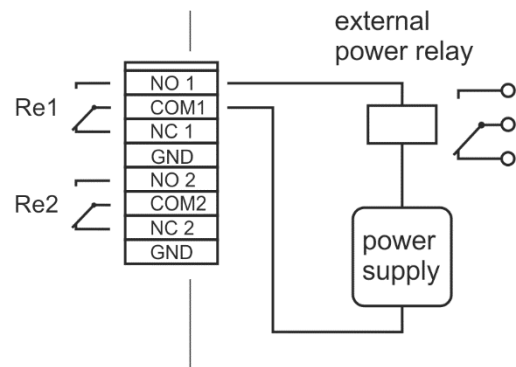

## 12. Appendix B

The probe for measuring the moisture of compressed air should be placed directly on the pressure pipelines to achieve higher measurement accuracy and fast response times. But there are cases where such placement is not possible. The reason is the high air speed, high temperature, high pollution, small diameter pipes, etc. Such situation can be solved by placing the probe into the flow measuring chamber. The picture shows the basic layout of the sampling system with chamber SH- PP.

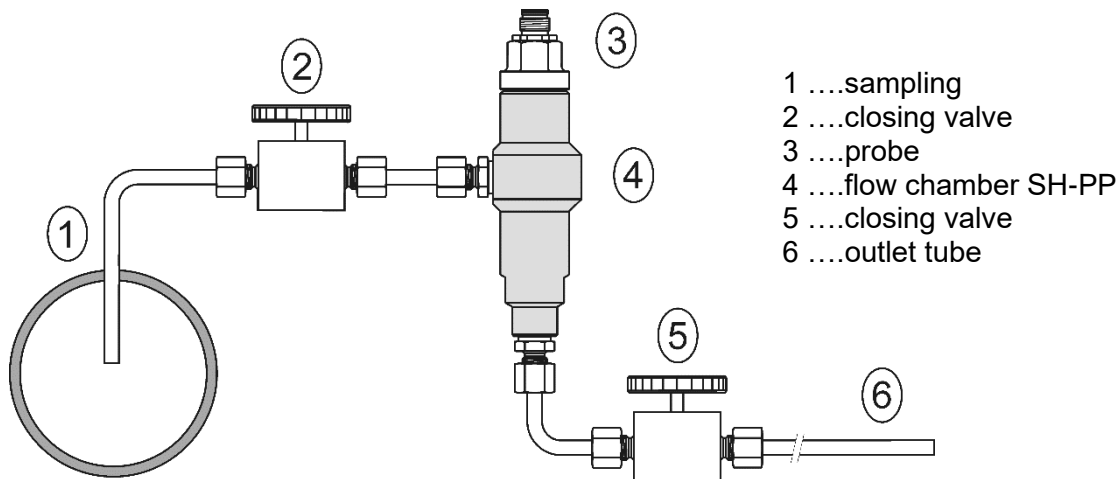

- 1 ....sampling
- 2 ....closing valve
- 3 ....probe
- 4 ....flow chamber SH-PP
- 5 ....closing valve
- 6 ....outlet tube

**sampling (1)** - end of the tube placed in the centre of pressure pipelines (distribution of moisture in the pipe cross-section is not homogeneous). To achieve fast response times to shorten the length of the sample tubes to a minimum (few meters).

**closing valve (2)** - allows access to the sample system without interrupting the main line

**closing valve (5)** - the sample flow is regulated by this valve. Measurement accuracy is typically not affected by the sample flow rate, but at low speeds, increasing response time.

**outlet tube (6)** - if the measured sample of air is released into the atmosphere, select the length of the outlet tube of 1.5 m (recommended for tube diameter 6mm). The reason is to ensure the accuracy of the sample in the flow chamber and avoid back diffusion of moisture from the ambient air..

That basic structure of sampling system can be supplemented with filters, coolers, flow measurement, pressure measurement, etc. For the accurate operation of sampling system is important to ensure perfect tightness of all connections and to use corrosion-resistant materials. Tube inclination is chosen so as to avoid the accumulation of fluid in the system.

## Technical specification – flow chamber SH-PP

<b>Material of flow chamber:</b>	stainless steel (DIN 1.4301)
<b>Inlet and outlet connection:</b>	G1/8
<b>Probe connection:</b>	G1/2
<b>Sample flow rate:</b>	0.1 to 3 l/min
<b>Operating pressure:</b>	up to 25 bar
<b>Weight:</b>	580 g

**Note:** Screw-coupling not included

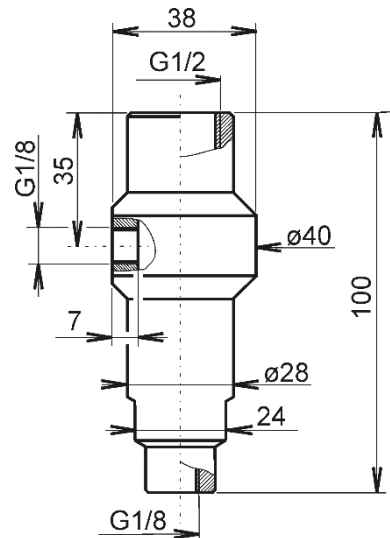

## 13. Appendix C

This chapter contains basic information about connection of the detectors (optional accessories) to binary inputs of regulator. The detectors install in accordance with the attached instructions for use.

### SP008 power detector

AC voltage presence sensor with optical indicator (green LED).

input voltage : 230Vac/50Hz

power plug : type C

response time : approx. 1 sec

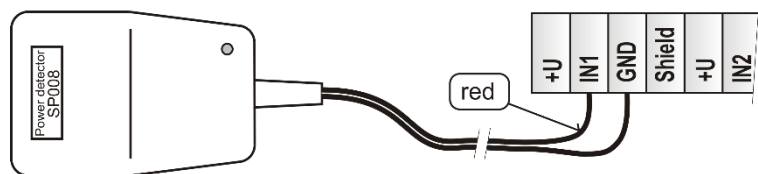

### LD-12 flood detector

This detector is a water flood indicator for cellars, bathrooms, ... The detector can be powered either from the regulator, or from an external power supply of 12Vdc. When an external power supply is used, connect the black wire to the terminal "GND", yellow wire to the terminal "IN1", (-) terminal of the power source to the terminal "GND" and the (+) terminal of the source to the red wire. If the detector is powered from the regulator **it is necessary to use power supply of 12Vdc for power supplying the regulator.**

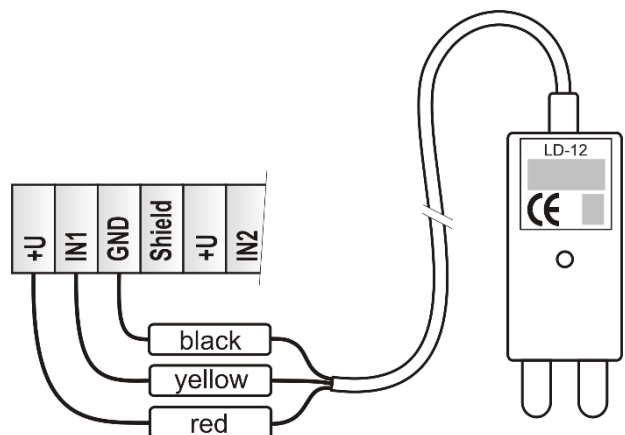

## SD-280 optical smoke detector

This device is designed to detect the presence of fire inside residential or commercial buildings. The detector can be powered either from the regulator, or from an external power supply of 12Vdc. When an external power supply is used, connect the terminals "ALARM" to the terminals "GND" and "IN1". If the detector is powered from the regulator **it is necessary to use power supply of 12Vdc for power supplying the regulator**

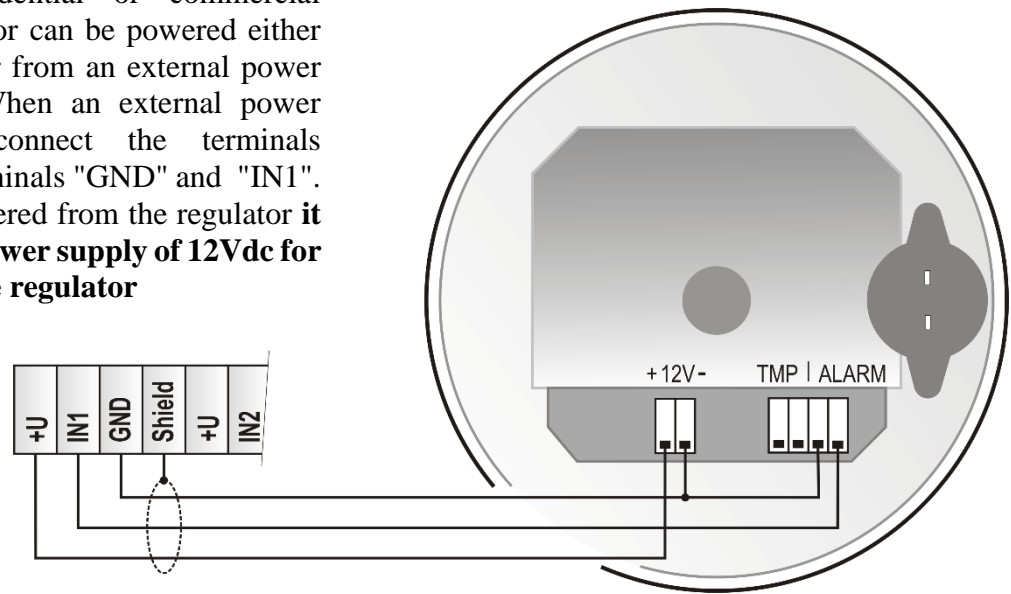

**Notice:** The connecting cables should be located as far as possible from the potential interference sources. The cable shield connect to "Shield" terminal of regulator only.

## 14. Appendix D

Wiring diagram of relay contacts for devices with serial number lower than **16981000**.

