

CENTER[®] 332

HOT WIRE ANEMOMETER

CE



Instruction Manual

CONTENTS

TITLE	PAGE
1. General Description	1
2. Safety Information	1
3. Application	1
4. Features	1
5. Specifications	2
6. Symbol Definition and Button Location	3
7. Button Instructions	6
7.1 Power ON/OFF/ Backlight button.....	6
7.2 Data-Hold button.....	6
7.3 MAX/MIN/AVG button.....	6
7.4 Flow button.....	6
7.5 Unit button.....	7
7.6 °C /°F Button.....	7
8. Operating Instructions	7
8.1 Setup Options.....	7
8.2 Menu Item.....	7
8.3 Menu Description.....	9
8.3.1 Set Duct Area.....	9
8.3.2 Set Absolute pressure.....	9
8.3.3 Set auto power off time.....	9
9. Measuring Procedure	10
9.1 Extending the Probe.....	10
9.2 Using the Telescoping Probe.....	10
10. Power Preparation	10
10.1 Battery Replacement.....	10
10.2 AC Adapter Connection.....	11
11. Maintenance	11

1. GENERAL DESCRIPTION

Thank you for choosing our Hot Wire Anemometer. To ensure the safety and the best performance of this instrument, we recommend you to read and follow the manual carefully before operation.

2. SAFETY INFORMATION

Read the following safety information carefully before attempting to operate or service the meter. Use the meter only as specified in this manual; otherwise, the protection provided by the meter may be impaired.

**** DANGER ****

The meter is not designed for use in gas mixtures other than air. **DO NOT** use the unit with corrosive or other dangerous or explosive gas mixtures.

DO NOT be caught in working machinery.

DO NOT touch any exposed electrical wiring, non-insulated or live parts.

ENVIRONMENT CONDITIONS

- Altitude up to 2000 meters
- Relatively humidity: 90% max
- Operation ambient temperature: 0°C to 50°C

MAINTENANCE & CLEARING

- Repairs or servicing not covered in this manual should only be performed by qualified personnel.
- Periodically wipe the case with a dry cloth. Do not use abrasives or solvents on this instrument.

SAFETY SYMBOLS

 Comply with EMC

When servicing, use only specified replacement parts.

3. APPLICATION

- Measuring volumetric flow rates or flow velocities in ducts
- Measuring the temperature and humidity of flows
- HVAC system performance

4. FEATURES

- Fast response.
- Telescoping hot wire probe.
- Air flow measure: CMM · CFM.
- Air velocity measurement:
m/s, km/hr, ft/min, MPH, Knots & build in temperature °C / °F, humidity RH.
- Large LCD display with backlight.
- Min/Max/Avg & 2/3Vmax function.
- Data Hold function.
- With USB interface supply power.



- Battery Life indicator.
- Adjustable auto power off timer.
- Air velocity compensation in atmospheric pressure.
- Tilt Stand.

5. SPECIFICATIONS

Velocity Probe Range:	0 to 25 m/s(0 to 5000 ft/min) 0 to 999900 m ³ /min(ft ³ /min) -20 °C ~60 °C (-4 °F ~140 °C) 0~100%RH
Resolution:	0.01 m/s(1 ft/min) 0.001 m ³ /min(ft ³ /min) 0.1 °C /°F 0.1%RH
Accuracy:	(at 23 °C ± 5 °C <80%RH) ±3% of reading ± 1%FS (0 to 20 m/s) ±5% of reading ± 1%FS (20 to 25 m/s) ±0.8 °C (±1.5 °F) ±3.5%RH at (20% ~ 80%RH) ±5%RH at (0% ~ 100%RH)
Warm Up Time:	5 seconds
Sample Rate	2 time per second
Battery:	9V Alkaline battery
USB Power Adapter:	DC 5V 0.5A
Battery Lifetime	Approx. 10 hours (alkaline battery)
Operation Temperature	
Meter / Probe :	0°C to 50°C (32°F to 122°F) / -20°C to 60°C (-4°F to 140°F)
Operation Humidity:	10 to 90%RH (no condensing)
Storage Temperature:	-20°C to 60°C (-4°F to 140°F)
Storage Humidity:	10 to 75%RH
Dimensions:	Meter: 185mm(L) × 65mm(W) × 36mm(H) / 7.28 inches(L) × 2.56 inches(W) × 1.41 inches(H) Wire length: 185 cm Probe length: 87 cm Probe diameter of tip: 9.0 mm Probe diameter of base:16.0 mm
Weight:	Approx.412 g(included battery and probe)
Standard Accessories :	Instruction manual, battery 9V Alkaline x 1 pcs, carrying case.

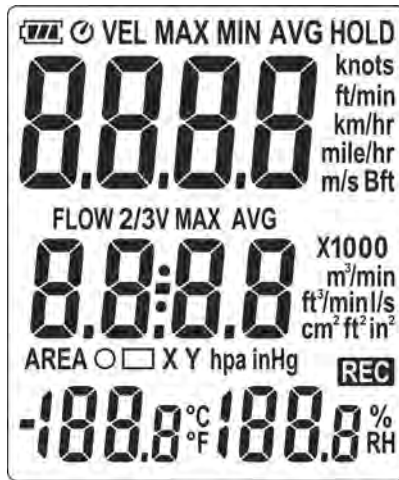
6. SYMBOL DEFINITION & BUTTON LOCATION



	: Battery condition indicator
VEL	: Air velocity indicator
MIN	: Air velocity Minimum indicator
MAX	: Air velocity Maximum indicator
AVG	: Air velocity Average indicator
	: Auto Power Off enabled indicator
8888	: Air velocity reading
knots ft/min km/hr mile/hr m/s Bft	: Air velocity measurement units
FLOW	: Air flow indicator
MAX	: Air flow Maximum indicator
2/3V MAX	: Air flow 2/3V Maximum indication
AVG	: Air flow Average indicator
8888	: Air flow reading

X10	: Multiply reading by ten
X100	: Multiply reading by one hundred
X1000	: Multiply reading by one thousand
m³/min ft³/min/s	: Air flow measurement units
cm² ft² in²	: Area setting units
AREA	: Duct Area indication
○	: Round Duct diameter dimension indication
□ XY	: Rectangle Duct X and Y dimension indication
hpa inHg	: Pressure indication
-188.8	: Temperature reading
°C °F	: Temperature measurement units
188.8	: Relative Humidity reading
% RH	: Relative Humidity measurement units
HOLD	: Data hold indication

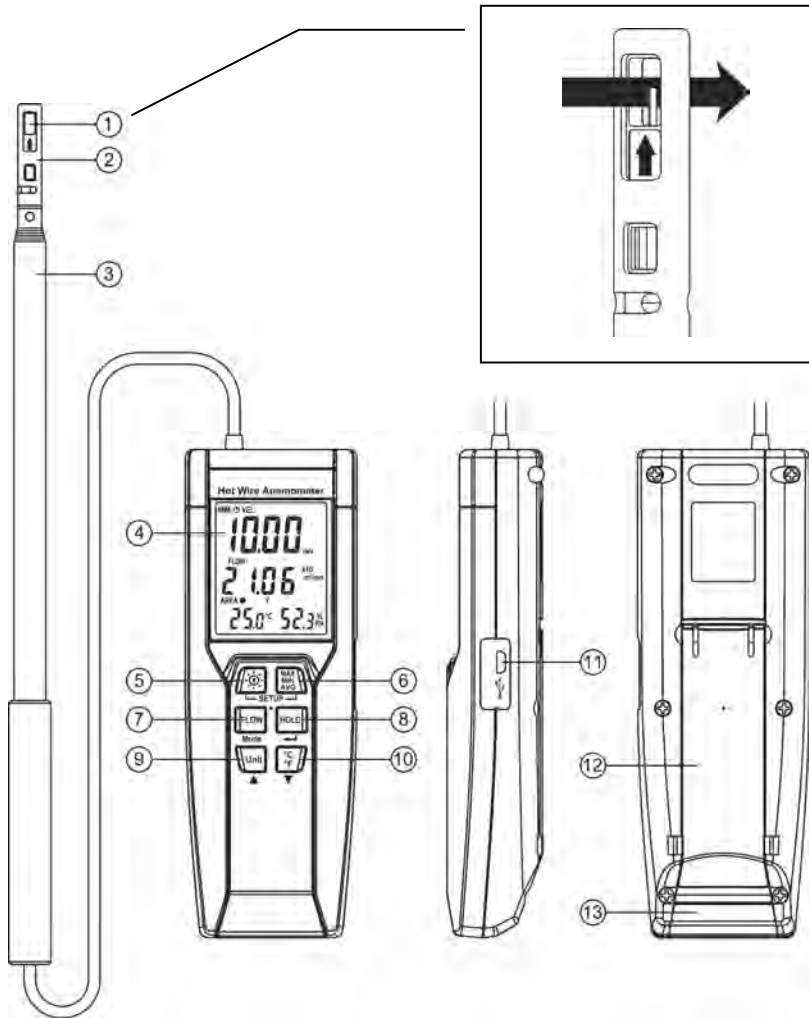





- ① Sensor Probe (Measurement direction)
- ③ Telescoping Probe
- ⑤ Power ON/OFF and Back Light Button
- ⑦ FLOW MAX 2/3V MAX AVG Button
- ⑨ Unit Button
- ⑪ Power Source Interface(micro USB type)
- ⑬ Battery Compartment

- ② Protective Shutter
- ④ Display Screen
- ⑥ MAX MIN AVG Button
- ⑧ DATA HOLD Button
- ⑩ °C/°F Button
- ⑫ Tilt Stand

7. BUTTON INSTRUCTIONS

7.1 Power ON/OFF/ Backlight Button:

Press the  button to turn on the meter and then press the  to turn on the LCD backlight. Press  again to turn off backlight. This makes it easier to read in dark environment. The backlight will be automatically turned off after 30 seconds to save battery power. Press and hold  button for 3 seconds to turn off. There is a 5 second count down as the meter warms up.

7.2 Data-Hold Button :





Press  button to freeze the data shown on the LCD screen. Press it again to exit Data-Hold mode.

Note: When the unit is in the Data-Hold mode,  /  /  /  buttons are disabled.

7.3 MAX/MIN/AVG Button:

Under this mode, the unit simultaneously monitors and stores the maximum, minimum and average value in the memory. The unit will keep updating/refreshing the data.

To start:

- (1) Press  button. “ **MAX** ” symbol lights up on LCD, the reading shows the maximum data.
- (2) Press  button again to show minimum data; the “ **MIN** ” symbol lights up on LCD.
- (3) Press  button again to show average data; the “ **AVG** ” symbol lights up on LCD.
- (4) Press  button again, the “ **MAX, MIN and AVG** ” symbol blinks together, the readings shows real time data.

To exit MAX/MIN/AVG mode:



Press and hold  button for 2 seconds to exit MAX/MIN/AVG mode.

7.4 FLOW Button :

AIR FLOW = (AIR VELOCITY) x (AREA)

Under this mode, the unit simultaneously monitors and stores the maximum, 2/3V maximum and average value in the Air flow. The unit will keep updating/refreshing the data.

To start:

- (1) Press  button. “ **MAX** ” symbol lights up on LCD, the reading shows the maximum data.
- (2) Press  button again to show two-third Velocity maximum data; the “ **2/3V MAX** ” symbol lights up on LCD.
- (3) Press  button again to show average data; the “ **AVG** ” symbol lights up on LCD.

- (4) Press  button again, the “ MAX, 2/3V MAX and AVG ” symbol blinks together, the reading shows real time data.

To exit MAX/2/3V MAX/AVG mode:

Press and hold  button for 2 seconds to exit MAX/2/3VMAX/AVG mode.

7.5 Unit Button:





Press  to select the desired unit of air velocity.

7.6 °C/°F Button:

Press  to select the desired unit of temperature.

8. OPERATING INSTRUCTIONS

8.1 Setup Options:

- (1) Power off the meter and then press the  and  button for 3 seconds to enter setup mode. Press  to exit anytime.
- (2) Press the  button to enter the setting option.
- (3) Press the  button to save changes and move to next setting option.

8.2 Menu Item:



(1) Fig.1 Setup mode.



(2) Fig.2 Set Area.



(3) Fig.3 Set Round Duct diameter dimension.



(4) Fig.4 Set Rectangle Duct X dimension.



(5) Fig.5 Set Rectangle Duct Y dimension.



(6) Fig.6 Set absolute pressure.



(7) Fig.7 Set auto power off time.

8.3 Menu Description:

8.3.1 Set Duct Area

There are 3 types : Duct Area (AREA), Round Duct (○), Rectangle Duct (□),

(1) Press the **FLOW** button to select the type and then press the **HOLD** button to confirm your choice.

(2) If duct area is chosen, the “**AREA**” symbol will displayed. (Fig.2)

Press the **Unit** or **°C/°F** button to set the size from 1 cm² to 40 m² (0.001 to 430.0 ft²).

Press the **HOLD** button to store the value.

If round duct is chosen, the (○) symbol will displayed. (Fig.3)

Press the **Unit** or **°C/°F** button to set the size (diameter) from 1 to 635 cm (0.4 to 250 in).

Press the **HOLD** button to store the value.

If rectangle duct is chosen, the “**□ X**” symbol will displayed. (Fig.4)

Press the **Unit** or **°C/°F** button to set the size of the duct ,then press the **HOLD** button to store the value and advance to the next dimension, the “**□ Y**” symbol will displayed.

Press the **Unit** or **°C/°F** button to set the size of the duct.

Press the **HOLD** button to store the value.

8.3.2 Set Absolute pressure

Press the **Unit** or **°C/°F** button to set absolute pressure from 100 to 2000 hpa (59 to 2.95 inHg) and then press the **HOLD** button to store the value.

8.3.3 Set auto power off time:

Press the **Unit** or **°C/°F** button to select auto power off option 10, 30 minutes, 1, 2, 4, 8 hours, or off. (see Fig.8 or Fig.9)



Fig.8



Fig.9

9. MEASURING PROCEDURE

9.1 Extending the Probe

Open the protective shutter and then extend the probe. Do not hold the cable while extending the probe.

9.2 Using the telescoping Probe

Put the probe in the right position and make sure that the sensor window is fully exposed and is facing upstream

* If in the right direction, the user will see the white-arrow marking as following figure



10. POWER PREPARATION

10.1 Battery Replacement:

(1) When the battery voltage drops below proper operation range, the  symbol will blink on the LCD display and the battery needs to be replaced.

(2) Before replacing the battery, power off the meter.

Open the cover of the battery cabinet. Replace the old batteries with new 9V alkaline battery (Carbon-zinc batteries are not recommended).

(3) Close the battery cabinet cover.

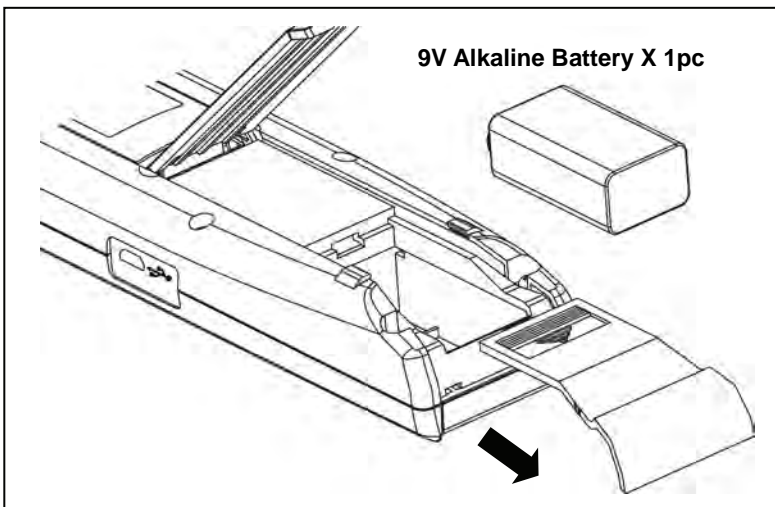

10.2 AC Adapter Connection:

When the AC adapter is used, insert the plugs of the adapter into the USB connector on the side panel.

Note:

When the AC adapter is connected while battery is inserted, the unit will be powered from the adapter (the AC adapter has priority).

11. Maintenance

Clean the device and the window of the display with a clean, lint-free, antistatic and dry cleaning cloth.

⚠ Do no use cleaning agents that contain carbon or benzenes, alcohol or anything similar to clean the product since these substances damage the surface of the measuring instrument. Moreover, these fumes are hazardous to health and explosive. Do not use tools with sharp edges, screwdrivers, metal brushes or anything similar to clean the device.

CENTER® CENTER TECHNOLOGY CORP.

4F, NO.415, Jung-Jeng Rd., Shu-Lin Dist., New Taipei City 238, Taiwan
TEL: 886-2-26763926 E-Mail : center@centertek.com
FAX: 886-2-26763925 http : // www.centertek.com

GCA000332-12000



Authorized Distributor in Australia & New Zealand
Pacific Sensor Technologies Pty Ltd
Unit 4, 3 Neutron Place Rowville, VIC 3178 Australia
1300 662 720 | sales@pacificsensortech.com.au
www.pacificsensortech.com.au